



RCMA421H WN-35BS



**Residual current monitor
for monitoring AC, DC and pulsed DC currents
in earthed and resistance earthed systems**

Software version D309 V1.0x



Bender GmbH & Co. KG

P.O. Box 1161 • 35301 Gruenberg • Germany

Londorfer Strasse 65 • 35305 Gruenberg • Germany

Tel.: +49 6401 807-0 • Fax: +49 6401 807-259

E-Mail: info@bender.de • www.bender.de

© Bender GmbH & Co. KG

All rights reserved.

Reprinting only with permission of the publisher.

Subject to change!

Photos: Bender archive

Table of Contents

1. Important information	5
1.1 How to use this manual	5
1.2 Technical support: service and support	6
1.2.1 First level support	6
1.2.2 Repair service	6
1.2.3 Field service	7
1.3 Training courses	8
1.4 Delivery conditions	8
1.5 Inspection, transport and storage	8
1.6 Warranty and liability	9
1.7 Disposal	10
2. Safety instructions	11
2.1 General safety instructions	11
2.2 Work activities on electrical installations	11
2.3 Intended use	12
2.4 Device-specific safety information	12
3. Function	13
3.1 Device features	13
3.2 Description of function	13
3.2.1 Transformer monitoring	14
3.2.2 Quick query of the rated residual operating current	14
3.2.3 Self test, automatic	15
3.2.4 Self test, manual	15
3.2.5 Malfunction	15
3.2.6 Password protection (on, OFF)	15
3.2.7 Factory setting FAC	16
3.2.8 Erasable history memory HiS	16

4. Installation and connection	17
4.1 Dimension diagrams	17
4.2 Factory setting	20
4.3 Commissioning	20
5. Operation and configuration	21
5.1 Getting to know the user interface	21
5.2 Understanding information on the standard display	22
5.3 Getting to know buttons and button functions	23
5.4 Starting a manual self test	24
5.5 Erasing the fault memory	24
5.6 Calling up and exiting the menu	24
5.7 Making settings in the menu	25
5.7.1 Selecting menus	25
5.7.2 Querying the software version with the InF menu	26
5.7.3 Making settings in the SEt menu	27
5.7.4 Querying and erasing the fault memory in the HIS menu	29
6. Technical data	31
6.1 Data RCMA421H-D-2 in table form	31
6.2 Error codes	34
6.3 Recommended contactors	35
6.4 Response times of the RCMA421H system plus contactor in accordance with UL943	36
6.5 Ordering information	37
6.6 Standards, approvals and certifications	37
INDEX	39

1. Important information

1.1 How to use this manual



This manual is intended for **qualified personnel** working in electrical engineering and electronics!

Always keep this manual within easy reach for future reference.

To make it easier for you to understand and revisit certain sections in this manual, we have used symbols to identify important instructions and information. The meaning of these symbols is explained below:



DANGER

This signal word indicates that there is a **high risk of danger** that will result in **electrocution** or **serious injury** if not avoided.



WARNING

This signal word indicates a **medium risk of danger** that can lead to **death** or **serious injury** if not avoided.



CAUTION

This signal word indicates a **low level risk** that can result in **minor** or **moderate injury or damage to property** if not avoided.



This symbol denotes information intended to assist the user in making **optimum use** of the product.

This manual has been compiled with great care. It might nevertheless contain errors and mistakes. Bender cannot accept any liability for injury to persons or damage to property resulting from errors or mistakes in this manual.

1.2 Technical support: service and support

For commissioning and troubleshooting Bender offers you:

1.2.1 First level support

Technical support by phone or e-mail for all Bender products

- Questions concerning specific customer applications
- Commissioning
- Troubleshooting

Telephone: +49 6401 807-760*
Fax: +49 6401 807-259
In Germany only: 0700BenderHelp (Tel. and Fax)
E-mail: support@bender-service.de

1.2.2 Repair service

Repair, calibration, update and replacement service for Bender products

- Repairing, calibrating, testing and analysing Bender products
- Hardware and software update for Bender devices
- Delivery of replacement devices in the event of faulty or incorrectly delivered Bender devices
- Extended guarantee for Bender devices, which includes an in-house repair service or replacement devices at no extra cost

Telephone: +49 6401 807-780** (technical issues)
+49 6401 807-784**, -785** (sales)
Fax: +49 6401 807-789
E-mail: repair@bender-service.de

Please send the devices for **repair** to the following address:

Bender GmbH, Repair-Service,
Londorfer Str. 65,
35305 Grünberg

1.2.3 Field service

On-site service for all Bender products

- Commissioning, configuring, maintenance, troubleshooting of Bender products
- Analysis of the electrical installation in the building (power quality test, EMC test, thermography)
- Training courses for customers

Telephone: +49 6401 807-752**, -762 **(technical issues)

+49 6401 807-753** (sales)

Fax: +49 6401 807-759

E-mail: fieldservice@bender-service.de

Internet: www.bender-de.com

*Available from 7.00 a.m. to 8.00 p.m. 365 days a year (CET/UTC+1)

**Mo-Thu 7.00 a.m. - 8.00 p.m., Fr 7.00 a.m. - 13.00 p.m

1.3 Training courses

Bender is happy to provide training regarding the use of test equipment. The dates of training courses and workshops can be found on the Internet at www.bender-de.com -> Know-how -> Seminars.

1.4 Delivery conditions

Bender sale and delivery conditions apply.

For software products the "Softwareklausel zur Überlassung von Standard-Software als Teil von Lieferungen, Ergänzung und Änderung der Allgemeinen Lieferbedingungen für Erzeugnisse und Leistungen der Elektroindustrie" (software clause in respect of the licensing of standard software as part of deliveries, modifications and changes to general delivery conditions for products and services in the electrical industry) set out by the ZVEI (Zentralverband Elektrotechnik- und Elektronikindustrie e. V.) (German Electrical and Electronic Manufacturer's Association) also applies.

Sale and delivery conditions can be obtained from Bender in printed or electronic format.

1.5 Inspection, transport and storage

Inspect the dispatch and equipment packaging for damage, and compare the contents of the package with the delivery documents. In the event of damage in transit, please contact Bender immediately.

The devices must only be stored in areas where they are protected from dust, damp, and spray and dripping water, and in which the specified storage temperatures can be ensured.

1.6 Warranty and liability

Warranty and liability claims in the event of injury to persons or damage to property are excluded if they can be attributed to one or more of the following causes:

- Improper use of the device.
- Incorrect mounting, commissioning, operation and maintenance of the device.
- Failure to observe the instructions in this operating manual regarding transport, commissioning, operation and maintenance of the device.
- Unauthorised changes to the device made by parties other than the manufacturer.
- Non-observance of technical data.
- Repairs carried out incorrectly and the use of replacement parts or accessories not approved by the manufacturer.
- Catastrophes caused by external influences and force majeure.
- Mounting and installation with device combinations not recommended by the manufacturer.

This operating manual, especially the safety instructions, must be observed by all personnel working on the device. Furthermore, the rules and regulations that apply for accident prevention at the place of use must be observed.

1.7 Disposal

Abide by the national regulations and laws governing the disposal of this device. Ask your supplier if you are not sure how to dispose of the old equipment.

The directive on waste electrical and electronic equipment (WEEE directive) and the directive on the restriction of certain hazardous substances in electrical and electronic equipment (RoHS directive) apply in the European Community. In Germany, these policies are implemented through the "Electrical and Electronic Equipment Act" (ElektroG). According to this, the following applies:

- Electrical and electronic equipment are not part of household waste.
- Batteries and accumulators are not part of household waste and must be disposed of in accordance with the regulations.
- Old electrical and electronic equipment from users other than private households which was introduced to the market after 13 August 2005 must be taken back by the manufacturer and disposed of properly.

For more information on the disposal of Bender devices, refer to our homepage at www.bender-de.com -> Service & support.

2. Safety instructions

2.1 General safety instructions

Part of the device documentation in addition to this manual is the enclosed "Safety instructions for Bender products".

2.2 Work activities on electrical installations



Only **qualified personnel** are permitted to carry out the work necessary to install, commission and run a device or system.



DANGER

Risk of electrocution due to electric shock!

Touching live parts of the system carries the risk of:

- An electric shock
- Damage to the electrical installation
- Destruction of the device

Before installing and connecting the device, make sure that the installation has been *de-energised*. Observe the rules for working on electrical installations.

If the device is used outside the Federal Republic of Germany, the applicable local standards and regulations must be complied with. The European standard EN 50110 can be used as a guide.

2.3 Intended use

{Enter device-specific text here}

The AC/DC sensitive residual current monitor RCMA421H with its measuring current transformer WN-35BS is used to monitor earthed and resistive earthed systems (TN and TT systems) in which DC and AC fault currents may occur. These systems involve loads with six-pulse bridge rectifiers or halfwave rectifiers with smoothing, e.g. converters and chargers.

In the event of a rated residual current $I_{\Delta n}$ of 6 mA, the device will switch an alarm relay and the associated contactor in accordance with the operating time specified in UL943.

In order to meet the requirements of the applicable standards, customised parameter settings must be made on the equipment in order to adapt it to local equipment and operating conditions. Please heed the limits of the range of application indicated in the technical data.

Any use other than that described in this manual is regarded as improper.

2.4 Device-specific safety information



CAUTION

According to UL943 every residual current monitor and the associated measuring current transformer is to be tested in pairs. The relevant serial number for the transformer is imprinted on the enclosure of the RCMA421H. The residual current monitor and the measuring current transformer assigned to it may only be used or interchanged in pairs.

3. Function

3.1 Device features

- AC/DC sensitive residual current monitor with external 35 mm measuring current transformer
- Can be used in conjunction with a contactor
- Rated residual operating current $I_{\Delta n} = 6 \text{ mA}$ acc. to UL943
- Operating time acc. to UL943
- r.m.s. value measurement, frequency range 0...150 Hz
- Measured value display via multi-functional LCD
- Alarm signalling via LEDs (TPD, ERR) and K2 changeover contact
- Password protection to prevent unauthorised changes being made to device settings
- Permanent fault memory
- N/C operation of alarm relay
- Device test when the power supply voltage is connected
- Automatic self test every 24 h
- CT connection monitoring
- Internal test circuit acc. to UL943 without additional external components
- External test and reset button can be connected
- N-PE conductor monitoring on the load side

3.2 Description of function

The RCMA421H runs a device test when the power supply voltage is connected. During the start-up phase, the TRP LED lights up, the alarm LED ERR flashes and the alarm relay switches to the alarm setting.

Once the device test has been completed successfully, the ERR alarm LED will stop flashing, the TPD LED will go out and the alarm relay will return to the normal setting.

The device will check the circuit for the presence of residual currents even during the self test.

An external measuring current transformer (e.g. WN-35BS) is used for residual current measurement. The actual measured value is indicated on the LCD. If the rated residual operating current of 6 mA is exceeded, the alarm relay K2 will change to the alarm state and the TRP alarm LED will light up.

Once the alarm relay has switched, the residual current must fall to less than the rated residual operating current.

If it does not, error code E.04 will appear on the display and the ERR alarm LED will flash. This means that the connected contactor has not shut down the faulty circuit.

If the residual current falls below the release value, the error will continue to be signalled due to the permanently activated fault memory. The alarm relay K2 will not switch back to the initial state and the TRP alarm LED will not go out until the reset button R is pressed or the power supply voltage is interrupted.

Parameters are assigned to the device via the LCD and the control buttons on the front panel; this function can be password-protected.

3.2.1 Transformer monitoring

The connections to the measuring current transformer are checked periodically every 10 s for short and open circuits. In the event of an error, the alarm relay K2 will switch, the red TPD alarm LED will light up and the yellow ERR alarm LED will flash (error codes E.01 or E.03). Once the error has been eliminated, the alarm LEDs and the alarm relay will remain in the alarm state. Pressing the reset button R or sending a reset command via the RS-485 interface will switch K2 back to its initial state and the alarm LEDs will go out.

3.2.2 Quick query of the rated residual operating current

When the display is in standard mode, the rated residual operating current $I_{\Delta n} = 6 \text{ mA}$ can be queried by pressing the Up or Down button (< 1.5 s). Switching to menu mode is not necessary. Quick query mode can be exited by pressing Enter (< 1.5 s).

3.2.3 Self test, automatic

The device runs a self test every 24 h. Any internal malfunctions detected are shown on the display as error codes. The automatic self test is carried out without internal fault current. The alarm relay is not switched during the 24-h test.

3.2.4 Self test, manual

The device runs a self test when the test button is pressed (> 1.5 s). Any internal malfunctions detected are shown on the display as error codes.

Whilst the test button T is pressed, all display elements available for this device are shown. When the button is released, the tES test symbol appears and the manual self test commences.

During the manual self test, an internal test current of approx. 7 mA is evaluated. Consequently, the TPD alarm LED lights up and the alarm relay switches. Once the alarm relay has switched, the residual current must fall to less than the rated residual operating current. If it does not, error code E.04 will appear on the display to indicate that the connected contactor has not shut down the load circuit.

If the self test has been successfully and the reset button R is pressed, the alarm LEDs will go out and the relay will switch to its initial state.

If the self test has not been successfully, the TPD alarm LED will light, the ERR alarm LED will flash, the alarm relay will switch to the alarm state and an error code will be displayed.

3.2.5 Malfunction

In the event of an internal malfunction, the TPD alarm LED will light and the ERR alarm LED will flash. An error code will appear on the display until the fault is removed. Refer to page 34 for details about error codes.

3.2.6 Password protection (on, OFF)

If password protection has been activated (on), settings can only be made subject to the correct password being entered (0...999).

3.2.7 Factory setting FAC

Activating the factory setting will reset all modified settings, with the exception of the device address, to the default upon delivery.

3.2.8 Erasable history memory HiS

The first alarm value to occur is written to this memory. The memory can be erased via the HiS menu.

4. Installation and connection



DANGER

Make sure that the installation area has been de-energised and ensure compliance with the regulations for working on electrical installations.

4.1 Dimension diagrams

RCMA421H dimension diagram and drawing for screw fixing

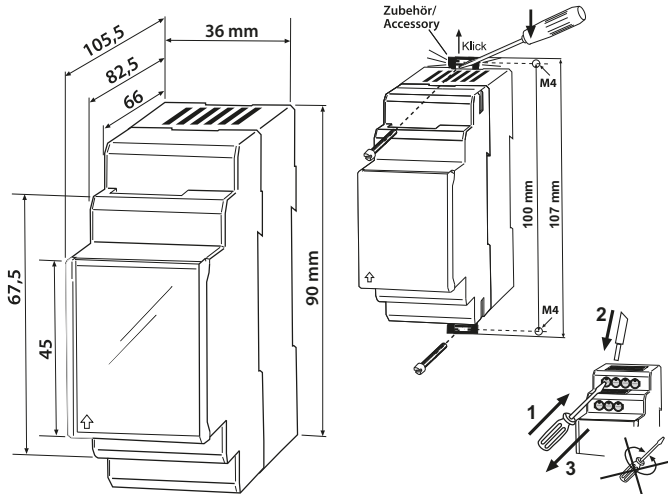

The front plate cover is easy to open at the lower part marked by an arrow.

Dimension diagram for measuring current transformer WN-35BS

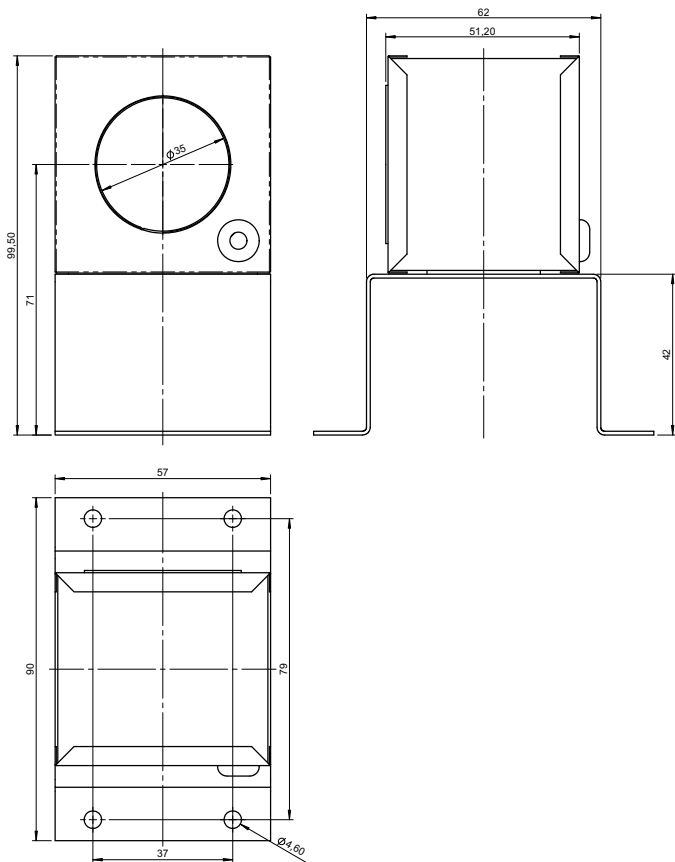

Dimensions in mm

1. Mounting on a DIN rail:

Snap the mounting clip at the rear of the device onto the DIN rail so that it sits securely.

Screw fixing:

Using the tool, position the rear mounting clips (a second mounting clip is required, see the ordering information) so that it protrudes over the enclosure. Fix the device in place with two M4 screws.

2. Wiring: The device must be wired as illustrated in the wiring diagram (example).

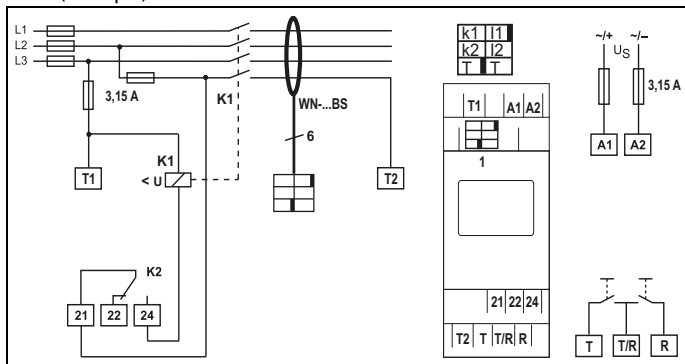

Terminal	Connections
A1, A2	Connection to the power supply
1	Bush for measuring current transformer's connecting cable
T1, T2	Test connections for internal monitoring circuit
T, T/R, R	Connections for external test and reset button
21, 22, 24	Alarm relay K2: Connection to contactor or load switch
WN-...BS	Measuring current transformers
K1	Recommended contactors are listed in the table on page 35

Conductor colours for measuring current transformer

Colour	Pin assignment	Colour	Pin assignment
brown	K1	black	I1
orange	K2	red	I2
pink	T	violet	T

4.2 Factory setting



<i>Rated residual operating current, fixed value</i>	<i>6 mA</i>
<i>Hysteresis, fixed value</i>	<i>15 %</i>
<i>Fault memory M</i>	<i>permanently activated</i>
<i>Mode of operation K2</i>	<i>permanent N/C operation (n.c.)</i>
<i>Password</i>	<i>0, deactivated (Off)</i>

4.3 Commissioning

Checks must be carried out prior to commissioning to ensure that the residual current monitor, the external measuring current transformer and the associated contactors and peripherals have been connected correctly.



CAUTION

Incorrect connections can lead to personal injury and damage to equipment or property!

5. Operation and configuration

5.1 Getting to know the user interface



Abb. 5.1: User interface

- 1 Green Power ON LED:
Lights up when the power supply voltage is connected and the device is running.
- 2 Red TPD alarm LED:
Lights up when the rated residual operating current $I_{\Delta n}$ is exceeded.
- 3 Yellow ERR alarm LED:
Flashes in the event of system errors. An error code will appear on the display, e.g. E.03
- 4 DISPLAY:
Displays operating information.
- 5 ENTER (< 1.5 s) / MENU (> 1.5 s) button:
Press this button to apply entries and changes and call up the menu.
- 6 DOWN (< 1.5 s) / RESET (> 1.5 s) button:
Press this button to reduce input values and navigate through the menu, as well as to perform a reset.
- 7 UP (< 1.5 s) / TEST (> 1.5 s) button:
Press this button to increase input values and navigate through the menu, as well as to run a manual self test.

5.2 Understanding information on the standard display

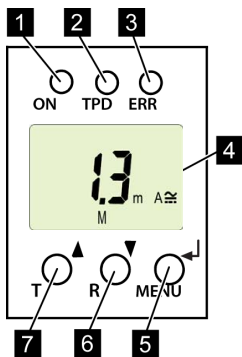

Abb. 5.1: Standard display

- 1 Measured value display in mA:
- 2 Current type display AC / DC
- 3 Password protection activated
- 4 Fault memory activated

The actual measured residual current is displayed by default.

Press the Up or Down button to display the factory-set rated residual operating current $I_{\Delta n}$. Pressing the Enter button restores the measured value.

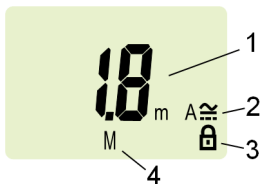

In standard operation, the display can be toggled to the fixed rated residual operating current $I_{\Delta n}$ of 6 mA using the Up/Down button.

5.3 Getting to know buttons and button functions

The table below lists the functions of the buttons when navigating through the display, navigating through the menu and when making settings. From "chapter 5.7 Making settings in the menu" in the menu onwards, just the relevant button symbol is used to indicate that buttons have been pressed.

Button	Button symbol	Function
Up/ Test	▲ T	<ul style="list-style-type: none"> • Call up next display • Go to the next menu/submenu/category item • Activate parameter • Change (increase) parameter value • Press and hold down button for more than 1.5 seconds: carry out the manual self test.
Down/ Reset	▼ R	<ul style="list-style-type: none"> • Call up next display • Go to next menu/submenu • Deactivate parameter • Change (reduce) parameter value • Press and hold down button for more than 1.5 seconds: erase fault memory
ENTER/ Menu	↵ MENU	<ul style="list-style-type: none"> • Call up menu/submenu • Apply modified parameter value • Press and hold down button for more than 1.5 seconds: Call up menu/exit menu/go to next highest submenu

5.4 Starting a manual self test

You can start a self test manually. During the test, any internal malfunctions detected are shown on the display as error codes. The alarm relay will be switched.

To start a self test manually:

- Press and hold down the test button T (UP) or external test button for more than 1.5 seconds.



The text "tES" appears on the display along with all available display elements.

5.5 Erasing the fault memory

The device has an erasable fault memory.

To erase the fault memory:

- Press and hold down the reset button "R" (DOWN) or external reset button for more than 1.5 seconds.

5.6 Calling up and exiting the menu

To call up the menu:

- Press and hold down the MENU (ENTER) button for more than 1.5 seconds.

To exit the menu again:

- Press and hold down the MENU (ENTER) button again for more than 1.5 seconds.









The areas of the display which can be configured flash! This is indicated by an oval marker in the illustrations below. Press and hold down the MENU button > 1.5 s to enter menu mode.

5.7 Making settings in the menu

5.7.1 Selecting menus

Press and hold down the MENU button for more than 1.5 seconds to call up the menu. Menus are available for a variety of settings. In turn, each menu has a number of submenus. The UP/DOWN buttons can be used to navigate between menus. Press and hold down the ENTER button for less than 1.5 seconds to call up a menu. Press and hold down the ENTER button for more than 1.5 seconds to go to the next highest menu.

Menu/Button to call	Description/Configurable parameters
	Query software version
	1. Press the UP/DOWN buttons to go to the menu
	Set bus address
	2. Press the UP/DOWN buttons to go to the menu
	Assign device control parameters <ul style="list-style-type: none"> • Activate or deactivate password protection, change password • Restore factory settings • Service menu SyS (locked)
	3. Press the UP/DOWN buttons to go to the menu
	Query saved alarm value, erase history memory

Menu/Button to call**Description/Configurable parameters**

4. Press the UP/DOWN buttons to go to the menu



Go to the next highest menu level (Back)

5.7.2 Querying the software version with the InF menu

1. Select the InF menu
2. Confirm with Enter

The software version (e.g.: d309-1.00) is displayed as running text. Once all information is showing on the display, you can use the UP/DOWN buttons to select individual items.









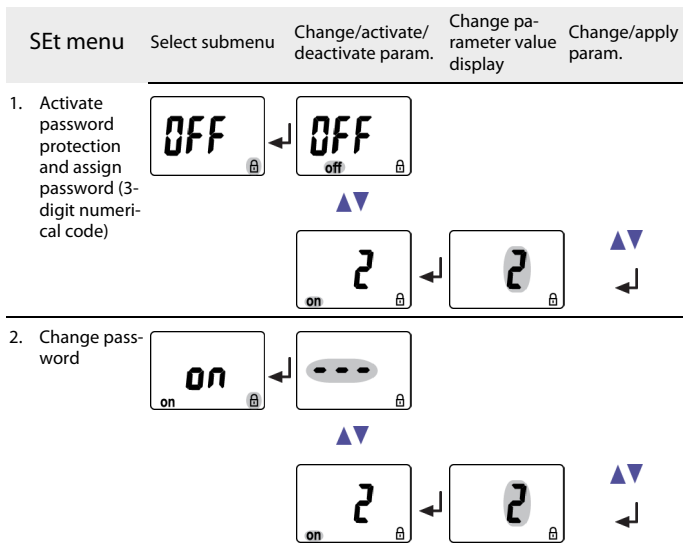

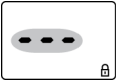



5.7.3 Making settings in the SEt menu

This menu can be used to activate password protection, to modify the password or to deactivate password protection. It is also where the device can be reset to the factory settings.

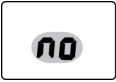
1. Select the SEt menu.
2. Make changes to parameters as illustrated.

To go back to the menu level, press and hold down the ENTER button for more than 1.5 seconds once you have modified the parameter(s).

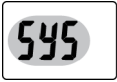

S/Et menu	Select submenu	Change/activate/ deactivate param.	Change pa- rameter value display	Change/apply param.
3. Deactivate password protection				
				
4. Switch sub-menu				
5. Restore factory setting				<p>"run" appears on the display and the device is reset to the factory settings automatically.</p>
				
6. Switch sub-menu				
7. System menu (is locked)				

SEt menu

Select submenu

Change/activate/
deactivate param.Change pa-
rameter value
displayChange/apply
param.

8. Switch sub-
menu



9. Go back to
SEt menu



5.7.4 Querying and erasing the fault memory in the HIS menu

1. Select the HIS menu.
2. Select the saved error and erase if applicable.
3. To go back to the menu level, press and hold down the ENTER button for more than 1.5 seconds.

HiS menu

Error display/Submenu

1. Error:
Rated residual operating cur-
rent exceeded

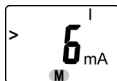

2. Switch error display



3. Error code E.03
see page 34



4. Switch error display



5. Erase fault memory



HiS menu

Error display/Submenu

6. Switch error display



7. Go back to HiS menu



6. Technical data

6.1 Data RCMA421H-D-2 in table form

()* = factory setting

Insulation coordination acc. to IEC 60664-1 / IEC 60664-3

RCMA421H-D-2:

Rated insulation voltage	250 V
Overvoltage category/ pollution degree	III/3
Rated impulse voltage	4 kV
Protective separation (reinforced insulation) between	(A1, A2) - (k/l, T/R) - (21, 22, 24)
Voltage tests according to IEC 61010-1	2.21 kV

Supply voltage

Supply voltage range U_s	AC/DC 100...250 V
Supply voltage U_s	AC/DC 70...300 V
Frequency range f_s	42...460 Hz
Power consumption	≤ 6.5 VA

Measuring circuit

External measuring current transformer	WN-35BS
Rated voltage (measuring current transformer)	2.5 kV
Rated frequency	0...150 Hz
AC/DC measuring range	0...40 mA
Relative uncertainty 0...20 Hz	-33%...+100%
Relative uncertainty 20...90 Hz	0...-33%
Relative uncertainty 90...150 Hz	± 17.5 %

Response value

Rated residual operating current $I_{\Delta n}$	6 mA
---	------

Time behaviour

Start-up delay t	operating time $t_{ae} + 3.2$ s
Operating time t_{ae} acc. to UL943	see diagram on page 36

Displays, memory

Display range. AC/DC measured value	0...40 mA
Resolution of setting	0.1 mA
Error of indication 0...20 Hz	-33%...+100% / ± 2 digits
Error of indication 20...90 Hz	0...20% / ± 2 digits
Error of indication 90...150 Hz	± 17.5% / ± 2 digits
Error of indication at $I_{\Delta} < 2 \text{ mA}$	± 7 digits
Measured value memory for alarm value (HiS)	Measured values data set
Password	off / 0...999 / 0 (off)*

Cable length, WN-35BS measuring current transformer

Cable length	0.5 m
--------------------	-------

Switching elements

Number of switching elements	1 changeover contact
Operating principle	N/C operation n.c.
Electrical service life under rated operating conditions	10000 switching cycles
Contact data acc. to IEC 60947-5-1	
Utilisation category	AC-13.....AC-14.....DC-12.....DC-12.....DC-12
Rated operational voltage	230V.....230V.....24V.....110V.....220 V
Rated operational voltage UL	200V.....200V.....24V.....110V.....200 V
Rated operational current	5 A.....3 A.....1 A.....0.2 A.....0.1 A
Minimum contact rating	1 mA at AC/DC ≥ 10 V

Environment / EMC

EMC	UL943
Operating temperature	-35 °C...+66 °C
Climatic class acc. to IEC 60721	
Stationary use (IEC 60721-3-3)	3K5 (except condensation and formation of ice)
Transport (IEC 60721-3-2)	2K3 (except condensation and formation of ice)
Long-term storage (IEC 60721-3-1)	1K4 (except condensation and formation of ice)
Classification of mechanical conditions acc. to IEC 60721:	
Stationary use (IEC 60721-3-3)	3M4
Transport (IEC 60721-3-2)	2M2
Long-term storage (IEC 60721-3-1)	1M3

Connection

For UL application	use 60/70 °C copper conductors only
Connection type	screw terminals
rigid/ flexible/ conductor sizes	0.2 . . . 4 / 0.2 . . . 2.5 mm ² / AWG 24 . . . 12
Multi-conductor connection (2 conductors with the same cross section)	
rigid, flexible	0.2 . . . 1.5 / 0.2 . . . 1.5 mm ²
Stripped length	8 . . . 9 mm
Tightening torque	0.5 . . . 0.6 Nm
Connection type	push-wire terminals
Connection properties:	
rigid	0.2 . . . 2.5 mm ² (AWG 24 . . . 14)
Flexible without ferrules	0.75 . . . 2.5 mm ² (AWG 19 . . . 14)
Flexible with ferrules	0.2 . . . 1.5 mm ² (AWG 24 . . . 16)
Stripped length	10 mm
Opening force	50 N
Test opening, diameter	2.1 mm

Other

Operating mode continuous operation	
Position of normal use	display-oriented
Degree of protection, internal components (IEC 60529)	IP30
Degree of protection, terminals (IEC 60529)	IP20
Enclosure material	polycarbonate
Flammability class	UL94V-0
DIN rail mounting acc. to	IEC 60715
Screw fixing	2 x M4 with mounting clip
Software version	D309 V1.0
Weight RCMA421H	≤ 150 g
Weight WN-35BS	≤ 355 g

()* = factory setting

6.2 Error codes

If, contrary to expectations, a device error should occur, error codes will appear on the display. Some of these are described below:



Error code	Meaning
E.01	Connection error: no transformer Action: Check transformer connection for short circuit or open circuit, from T to T and from k2 to I2.
E.02	Connection error: connection system (after finishing manual self test) Action: Check transformer connection for short-circuit or open circuit. - Check correct connection, from T1 to T2.
E.03	Connection error: short-circuit transformer Action: Check transformer connection for short-circuit or open circuit.
E.04	Error K1/Q1 (following powering up the device) Action: Check contactor: e.g. contacts sticking, release coil faulty
E...	Error codes > 04: Action: Perform a reset. Restore the device to the factory setting. Should the error persist, contact Bender Service.

After removing the CT mains connector, the error code E.03 / E.04 alternately appears on the display.

The error code will be erased automatically once the error has been eliminated.

6.3 Recommended contactors

The ABB types listed below have undergone performance testing:

Contactor type	Main contact	Auxiliary contact	
			
A16-30-10-84	3	1	
A26-30-10-84	3	1	
A40-30-10-84	3	1	
A75-30-00-84	3		
A110-30-00-84	3		
A145-30-00-84	3		
A16-30-10-34	3	1	
A26-30-10-34	3	1	
A40-30-10-34	3	1	
A75-30-00-34	3		
A110-30-00-34	3		
A145-30-00-34	3		
A16-40-00-84	4		
A26-40-00-84	4		
A45-40-00-84	4		
A75-40-00-84	4		
EK150* -40-22	4	2	2
A16-40-00-34	4		
A26-40-00-34	4		
A45-40-00-34	4		
A75-40-00-34	4		
EK150** -40-22	4	2	2

6.4 Response times of the RCMA421H system plus contactor in accordance with UL943

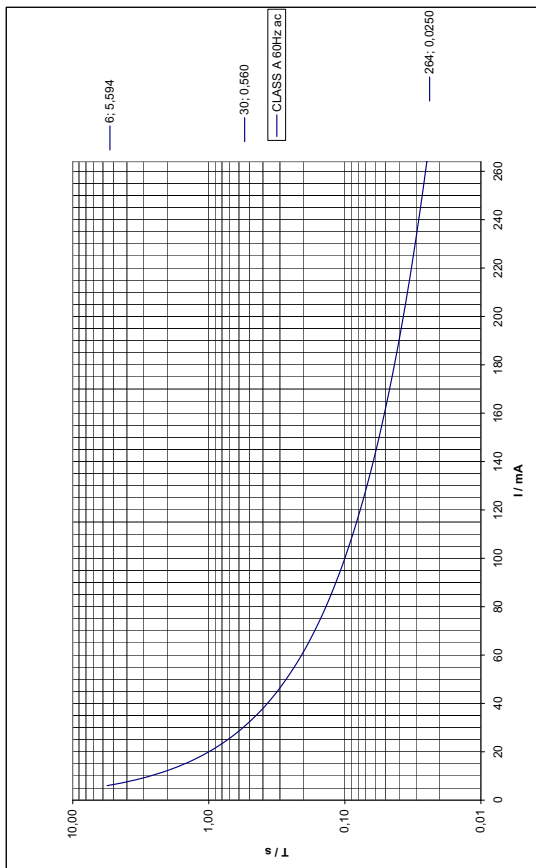

6.5 Ordering information

	RCMA421H-D2
Rated residual operating current $I_{\Delta n}$	6 mA
Rated frequency	0...150 Hz
Supply voltage U_s^*	AC/DC 70...300 V AC 42...460 Hz
Art. No.: with screw terminal	B94043019 ¹⁾
with push-wire terminal	B94043015 ^{1), 2)} B74043019 ¹⁾

*Absolute values of the voltage range

¹⁾ UL508; ²⁾ UL943

External measuring current transformer

Type	Internal diameter (mm)	Art. No.
WN-35BS	35	B 9808 0044

RCMA421H accessories

Mounting clip for screw fixing (1 per device) B 9806 0008

6.6 Standards, approvals and certifications



INDEX

A

Accessories 37

B

Button functions 23

C

Commissioning 20

Conductor colours for measuring current
transformer 20

D

Description of function 13

Device features 13

Device test 13

Dimension diagrams 17

E

Error codes 34

F

Factory setting 16, 20

H

HiS menu 29

History memory 16

How to use this manual 5

I

Installation and connection 17

Intended use 12

M

Malfunction 15

Menu, settings 25

Multi-conductor connection 33

O

Operation and configuration 21

Ordering information 37

P

Parameter setting

- Activating or deactivating the pass-
word protection 27

Password protection 15

Push-wire terminal 33

Q

Querying and erasing the fault memory 29

Quick query of the rated residual operating
current 14

R

Recommended contactors 35

Response times 36

Restore factory settings 28

RS-485 interface 17

S

screw terminals 33

Self test, automatic 15

Self test, manual 15, 24

Service 6

Set bus address 27

SEt menu 27

Support 6

T

Technical data 31

To call up the menu 24

To exit the menu 24

Training courses 8

W

Wiring diagram 19

Work activities on electrical installations 11

workshops 8



Bender GmbH & Co. KG

P.O. Box 1161 • 35301 Gruenberg • Germany
Londorfer Strasse 65 • 35305 Gruenberg • Germany
Tel.: +49 6401 807-0 • Fax: +49 6401 807-259
E-Mail: info@bender.de • www.bender.de

Photos: Bender archives



BENDER Group