



AC/DC

ISOMETER® isoMIL425

Insulation monitoring device
for unearthed AC-, AC/DC and DC systems
in military applications up to 3(N)AC, AC/DC 400 V
Software version: D0459 V1.xx



Table of contents

1	General information.....	5
1.1	How to use the manual.....	5
1.2	Indication of important instructions and information.....	5
1.3	Signs and symbols.....	5
1.4	Service and Support.....	5
1.5	Training courses and seminars.....	6
1.6	Delivery conditions.....	6
1.7	Inspection, transport and storage.....	6
1.8	Warranty and liability.....	6
1.9	Disposal of Bender devices.....	7
1.10	Safety.....	7
2	Function.....	8
2.1	Intended use.....	8
2.2	Device features.....	8
2.3	Functional description.....	9
2.3.1	Monitoring the insulation resistance (R mode).....	9
2.3.2	Monitoring of the insulation impedance (Z mode).....	10
2.3.3	Undervoltage/overvoltage monitoring.....	10
2.3.4	Self test/error codes.....	10
2.3.5	Malfunction.....	12
2.3.6	Alarm assignment of the alarm relays K1/K2.....	12
2.3.7	Measuring and response times.....	12
2.3.8	Password protection (on, OFF).....	13
2.3.9	External test/reset button (T/R).....	13
2.3.10	Fault memory.....	14
2.3.11	History memory HiS.....	14
2.3.12	Digital interface.....	14
3	Installation, connection and commissioning.....	15
3.1	Dimensions.....	15
3.2	Installation.....	15
3.3	Connection.....	16
3.4	Commissioning.....	17
4	Operation.....	18

4.1	Operating and display elements.....	18
4.2	Menu overview.....	20
4.3	Displaying measured values.....	21
4.4	Setting the response values (AL).....	22
4.4.1	Setting the response values for monitoring the insulation resistance (R mode) or the insulation impedance (Z mode).....	22
4.4.2	Setting the response values for undervoltage and overvoltage.....	22
4.4.3	Response values overview.....	22
4.5	Configuring fault memory, alarm relays, and interfaces (out).....	23
4.5.1	Configuring the relays.....	23
4.5.2	Assigning the alarm messages to the relays.....	23
4.5.3	Activating or deactivating fault memory.....	24
4.5.4	Configuring interface.....	24
4.6	Setting delay times and self test cycles (t).....	24
4.7	Setting device control parameters (SEt).....	25
4.8	Reset to factory settings.....	25
4.9	Showing and deleting the history memory.....	26
4.10	Querying software version (InF).....	26
5	Data access via RS-485 interface.....	27
5.1	Data access using the BMS protocol.....	27
5.2	Data access using the Modbus RTU protocol.....	27
5.2.1	Reading out the Modbus register from the ISOMETER®.....	27
5.2.2	Writing the Modbus register (parameter setting).....	28
5.2.3	Exception code.....	29
5.3	Modbus register assignment.....	30
5.3.1	Modbus measured value registers.....	30
5.3.2	Modbus parameter register.....	33
5.4	IsoData data string.....	37
6	Technical data.....	39
6.1	Technical data isoMIL425.....	39
6.2	Connection.....	43
6.3	Standards and certifications.....	43
6.4	Ordering data.....	44
6.5	Change log.....	44

1 General information

1.1 How to use the manual

**ADVICE**

This manual is intended for qualified personnel working in electrical engineering and electronics! Part of the device documentation in addition to this manual is the enclosed supplement "Safety instructions for Bender products".

**ADVICE**

Read the operating manual before mounting, connecting and commissioning the device. Keep the manual within easy reach for future reference.

1.2 Indication of important instructions and information

**DANGER**

Indicates a high risk of danger that will result in death or serious injury if not avoided.

**WARNING**

Indicates a medium risk of danger that can lead to death or serious injury if not avoided.

**CAUTION**

Indicates a low-level risk that can result in minor or moderate injury or damage to property if not avoided.

**ADVICE**

Indicates important facts that do not result in immediate injuries. They can lead to malfunctions if the device is handled incorrectly.



Information can help to optimise the use of the product.

1.3 Signs and symbols



Disposal



Protect from moisture



Protect from dust

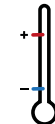

Temperature range



Recycling



RoHS directives

1.4 Service and Support

Information and contact details about customer service, repair service or field service for Bender devices are available on the following website: Fast assistance | Bender GmbH & Co. KG.

1.5 Training courses and seminars

Regular face-to-face or online seminars for customers and other interested parties:

www.bender.de > know-how > seminars.

1.6 Delivery conditions

The conditions of sale and delivery set out by Bender GmbH & Co. KG apply. These can be obtained in printed or electronic format.

The following applies to software products:



'Software clause in respect of the licensing of standard software as part of deliveries, modifications and changes to general delivery conditions for products and services in the electrical industry'

1.7 Inspection, transport and storage

Check the shipping and device packaging for transport damage and scope of delivery. In the event of complaints, the company must be notified immediately, see "www.bender.de > service & support".

The following must be observed when storing the devices:

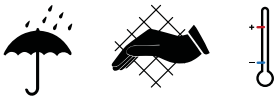

1.8 Warranty and liability

Warranty and liability claims for personal injury and property damage are excluded in the case of:

- Improper use of the device.
- Incorrect mounting, commissioning, operation and maintenance of the device.
- Failure to observe the instructions in this operating manual regarding transport, commissioning, operation and maintenance of the device.
- Unauthorised changes to the device made by parties other than the manufacturer.
- Non-observance of technical data.
- Repairs carried out incorrectly.
- The use of accessories or spare parts that are not provided, approved or recommended by the manufacturer.
- Catastrophes caused by external influences and force majeure.
- Mounting and installation with device combinations not approved or recommended by the manufacturer.

This operating manual and the enclosed safety instructions must be observed by all persons working with the device. Furthermore, the rules and regulations that apply for accident prevention at the place of use must be observed.

1.9 Disposal of Bender devices

Abide by the national regulations and laws governing the disposal of this device.



For more information on the disposal of Bender devices, refer to www.bender.de > service & support.

1.10 Safety

If the device is used outside the Federal Republic of Germany, the applicable local standards and regulations must be complied with. In Europe, the European standard EN 50110 applies.



DANGER *Risk of fatal injury due to electric shock!*

Touching live parts of the system carries the risk of:

- Risk of electrocution due to electric shock
- Damage to the electrical installation
- Destruction of the device

Before installing the device and before working on its connections, make sure that the installation has been de-energised. The rules for working on electrical systems must be observed.

2 Function

2.1 Intended use

The ISOMETER® monitors the insulation resistance R_F (R mode) or the insulation impedance (Z mode) of unearthed AC/DC main circuits (IT systems) with nominal system voltages of 3(N)AC, AC, AC/DC or DC 0...400 V, 15...460 Hz.

DC components existing in 3(N)AC, AC/DC systems do not influence the operating characteristics when a minimum load current of DC 10 mA flows. The separate supply voltage U_s allows de-energised systems to be monitored as well.

The maximum permissible system leakage capacitance is 300 μF in R mode and 1 μF in Z mode.

In order to meet the requirements of the applicable standards, customised parameter settings must be made on the equipment in order to adapt it to local equipment and operating conditions. Please heed the limits of the range of application indicated in the technical data.

Any other use or a use that goes beyond this constitutes improper use.

i *To ensure that the ISOMETER® functions correctly, an internal resistance of $\leq 1 \text{ k}\Omega$ must exist between L1/+ and L2/- via the source (e.g. PSU) or the load.*

i *If the ISOMETER® is installed inside a control cabinet, the insulation fault message must be audible and/or visible to attract attention.*

2.2 Device features

- Monitoring of the insulation resistance R_F (R mode) or of the insulation impedance Z_F (Z mode) for unearthed 3(N)AC, AC and DC systems with galvanically connected rectifiers or frequency converters
- Insulation impedance Z_F (Z mode) for 50 Hz or 60 Hz
- Measuring the system voltage U_n (True-RMS) with undervoltage/overvoltage detection
- Measuring the DC residual voltages U_{L1e} (between L1/+ and earth) and U_{L2e} (between L2/- and earth)
- Selectable start-up delay, response delay and delay on release
- Alarm output via LEDs ("AL1", "AL2"), display, and alarm relays ("K1", "K2")
- Automatic device self test with connection monitoring
- Selectable n/c or n/o relay operation
- Measured value indication via multi-functional LC display
- Activatable fault memory
- Automatic adjustment to the system leakage capacitance C_e up to 300 μF in R mode and 1 μF in Z mode
- Two separately adjustable response value ranges 1...990 $\text{k}\Omega$ (prewarning, alarm)
- RS-485 (galvanically isolated) including the following protocols:
 - BMS (Bender measuring device interface) for the data exchange with other Bender devices
 - Modbus RTU
 - IsoData (for continuous data output)
- Password protection against unauthorised changing of parameters

2.3 Functional description

The ISOMETER® measures the insulation resistance R_F and the system leakage capacitance C_e between the system to be monitored (L1/+, L2/-) and earth (PE). Z mode (selectable in the "SEt" menu) calculates the insulation impedance Z_F from R_F and C_e with a system frequency parameter $f_n = 50$ Hz or $f_n = 60$ Hz. The RMS value of the system voltage U_n between L1/+ and L2/- as well as the residual voltages U_{L1e} (between L1/+ and earth) and U_{L2e} (between L2/- and earth) are also measured.

From a minimum system voltage, the ISOMETER® determines the faulty conductor "R %", which shows the distribution of the insulation resistance between conductors L1/+ and L2/-. The distribution is indicated by a positive or negative sign preceding the insulation resistance measurement. The value range of the faulty conductor is ± 100 %:

Indication	Meaning
-100 %	one-sided fault at conductor L2/-
0 %	symmetrical fault
+100 %	one-sided fault at conductor L1/+

The partial resistances can be calculated from the total insulation resistance R_F and the faulty conductor "R %" using the following formula:

- **Fault at conductor L1/+:** $R_{L1F} = (200 \% \times R_F) / (100 \% + R \%)$
- **Fault at conductor L2/-:** $R_{L2F} = (200 \% \times R_F) / (100 \% - R \%)$

Also from a minimum system voltage, the ISOMETER® determines the insulation resistance R_{UGF} from the residual voltages U_{L1e} and U_{L2e} . It is an approximate value for one-sided insulation faults and can be used as a trend indicator in cases where the ISOMETER® has to adapt to an R_F and C_e relation that varies considerably.

The detected fault is assignable to an alarm relay via the menu. If the values R_F , Z_F or U_n violate the response values activated in the "AL" menu, this will be indicated by the LEDs and relays "K1" and "K2" according to the signalling assignment set in the "out" menu. In addition, the menu offers the setting of the relay operation and the activation of the fault memory "M".

If the values R_F , Z_F or U_n do not violate their release value (response value plus hysteresis) for the period t_{off} without interruption, the alarm relays will switch back to their initial position and the alarm LEDs stop lighting. If the fault memory is activated, the alarm relays remain in alarm position and the LEDs are lit until the reset key "R" is pressed or the supply voltage U_s is interrupted.

The device function can be checked with the test button "T".

Parameters are assigned to the device via the LCD and the control buttons on the front panel; this function can be password-protected. Parameterisation is also possible via the BMS bus, for example by using the BMS Ethernet gateway (COM465IP) or the Modbus RTU.

2.3.1 Monitoring the insulation resistance (R mode)

The insulation resistance R_F is monitored by means of the parameters "R1" (prewarning) and "R2" (alarm) (see chapter 4.4.3). The value "R1" can only be set higher than the value "R2". If the insulation resistance R_F reaches or falls below the activated values "R1" or "R2", an alarm message is triggered. If R_F exceeds the values "R1" or "R2" plus the hysteresis value, the alarm will be cleared.

i Each time the mode is switched from R mode to Z mode, parameters “R1” and “R2”, and hence the monitoring of the insulation resistance R_F will be deactivated.

In Z mode the insulation impedance Z_F is the main measured value and the measured insulation resistance R_F may have increased tolerances depending on the system condition. If required, the parameters “R1” and “R2” can also be activated in Z mode.

2.3.2 Monitoring of the insulation impedance (Z mode)

In Z mode the parameters “Z1” and “Z2” for monitoring the insulation impedance Z_F are available in the “AL” menu. The value “Z1” must be set higher than value “Z2”. The insulation impedance Z_F for the selected system frequency f_n (50 Hz or 60 Hz in the “SEt” menu) can be calculated from the measured values R_F and C_e using the formula below:

$$X_{ce} = \frac{1}{2 \cdot \pi \cdot f_n \cdot C_e}$$

The lower resistance component of R_F or X_{ce} determines the amount of Z_F . The higher resistance component of R_F or X_{ce} may have an increased tolerance due to the measuring signal resolution.

If the insulation impedance Z_F reaches or falls below the activated values “Z1” or “Z2”, an alarm message will be signalled. If Z_F exceeds the values “Z1” or “Z2” plus the hysteresis value (see table in chapter 4.4.3), the alarm will be cleared.

2.3.3 Undervoltage/overvoltage monitoring

To monitor the system voltage U_n , the two parameters “U<” and “U>” can be enabled in the response-value menu “AL” (chapter 4.4). The maximum undervoltage value is limited by the overvoltage value.

The RMS value of the system voltage U_n is monitored. If the system voltage U_n reaches, falls below, or exceeds the limit values “U<” and “U>”, an alarm will be signalled. If the maximum permissible system voltage U_n set for the ISOMETER® is exceeded, an alarm message will be triggered even if the overvoltage limit value has been deactivated. The alarm will be deleted when the limit values plus hysteresis (chapter 4.4.1) are no longer violated.

2.3.4 Self test/error codes

The **self test** checks the function of the ISOMETER®, and monitors the connection to earth as well as the connection to the system to be monitored. The alarm relays do not switch during an automatically started self test. For a self test started manually, the switching of the alarm relays can be set using the parameter “test” in the alarm assignment (menu “out”, chapter 4.5.2). During the test, the display indicates “tES”.

When malfunctions are detected or connections are missing, the LEDs “ON”/“AL1”/“AL2” flash. The display shows the respective error codes (“E.xx”), and in the factory setting relay “K2” switches. The relays can be assigned to a device error with the parameter “Err” in the “out” menu in the alarm assignment.

2.3.4.1 Error codes

In the event of a device error the display shows the respective **error code**.

Overview of some error codes

Error code	Meaning
E.01	<p>PE connection error The connection of "E" or "KE" to earth is interrupted. Action: Check connection, eliminate error. The error code will be erased automatically once the error has been eliminated.</p>
E.02	<p>System connection error The internal resistance of the system is too high or the connection of "L1/+" or "L2/-" to the system is interrupted. The terminals "L1/+" and "L2/-" are connected incorrectly. Action: Check connection, eliminate error. The error code will be erased automatically once the error has been eliminated.</p>
E.05	<p>Measurement error Due to system interferences or a device error, the insulation measured value is no longer updated. Prewarning and alarm are set for the insulation measured value at the same time. Calibration invalid after software update "E.05" appears together with "E.08": The software is not compatible to the calibration of the device. Action: Install the previous software version or have the device calibrated at the factory.</p>
E.07	<p>Permissible system leakage capacitance C_e exceeded The device is not suitable for the present network leakage capacitance C_e. Action: Uninstall the device.</p>
E.08	<p>Calibration error Action: Check connection, eliminate error. If the error is still present, there is a device error.</p>

Internal device errors "E.xx" can be caused by external disturbances or internal hardware errors. If the error message occurs again after the device has been restarted or after a reset to the factory settings (menu item "FAC"), the device must be repaired. After the fault has been eliminated, the alarm relays switch back either automatically or when the reset button is pressed. The self test can take a few minutes.

2.3.4.2 Automatic self test

In the factory setting a self test is carried out when the supply voltage U_s is connected and after that every 24 h. This cycle can be adjusted: off, 1 h, 24 h (see chapter 4.6).

The self test can be disabled for the device start so that the device can enter the measurement mode more quickly. To this end, set the parameter "S.Ct = off" in the menu "SET".

2.3.4.3 Manual self test

The manual self test is started by pressing the external test/reset button or the test button "T" on the device for > 1.5 s. Holding the test button "T" also shows all display elements.

2.3.4.4 Connection monitoring

Connection monitoring, activated by the self test, checks the connections of terminals “E” and “KE” to the protective earth conductor (PE). When an error is detected, the message device error (“Err”) is signalled and the error code “E.01” appears on the display.

The system connection monitoring checks the connection of terminals “L1/+” and “L2/-” to the system to be monitored. When an interruption or a high-resistance connection between L1/+ and L2/- is detected via the internal resistance of the system, the device error (“Err”) is signalled and the error code “E.02” appears on the display. Since a test of the system connection may take considerable time or even provide incorrect results due to system disturbances, the connection monitoring can be switched off using the parameter “nEt” in the “SEt” menu.

2.3.5 Malfunction

The device checks some of its functions continuously during operation. If a fault is detected, the device error (“Err”) will be signalled, “E.xx” appears on the display as an identifier for error type xx, and the LEDs “ON”/“AL1”/“AL2” will flash.

Please contact Bender Service, if the error occurs again after the device has been restarted or the factory settings have been restored.

2.3.6 Alarm assignment of the alarm relays K1/K2

The notifications for “device error”, “insulation fault”, “undervoltage/overvoltage fault”, “device test” and “device start with alarm” can be assigned to the alarm relays via the “out” menu.

An **insulation fault** is indicated by these messages:

- “+R1” and “+R2”: insulation fault assigned to conductor L1/+
- “-R1” and “-R2”: insulation fault assigned to conductor L2/-

If an assignment to a conductor is not possible, e.g. due to a symmetrical insulation fault, the respective “+” and “-” messages are set together.

The message “test” indicates a **device test** triggered manually via a test button or the communication interface.

The message “S.AL” indicates a **device start with alarm**. When the parameter value is set to “S.AL = on” and the supply voltage U_s is connected, the ISOMETER® starts with the insulation measured value $R_F = 0 \Omega$ and $Z_F = 0 \Omega$ in Z mode and sets all activated alarms. The alarms will be cleared only when the measured values are up-to-date and no thresholds are violated. In the factory setting “S.AL = off”, the ISOMETER® starts without an alarm.



Recommendation: Set parameter value “S.AL” identical for both relays.

2.3.7 Measuring and response times

The measuring time is the period essential for the detection of the measured value. The measuring time is reflected in the operating time t_{ae} . For the insulation resistance measured value, it is mainly determined by the necessary measuring pulse duration, which depends on the insulation resistance R_F and the system leakage capacitance C_e of the system to be monitored. The measuring pulse is generated by the measuring pulse generator integrated in the ISOMETER®. The measuring times for C_e , U_{L1e} , U_{L2e} and R % are synchronous.

System disturbances may lead to extended measuring times. In contrast, the time for the system voltage measurement U_n is independent and considerably shorter.

Operating time t_{ae}

The operating time t_{ae} is the time required by the ISOMETER® to determine the measured value. The insulation resistance measured value depends on the insulation resistance R_F and the system leakage capacitance C_e .

Example: A maximum permissible system leakage capacitance of $C_e = 300 \mu\text{F}$ and an insulation fault of $R_F = 2.5 \text{ k}\Omega$ ($R_{an} = 5 \text{ k}\Omega$) in a DC 400 V system result in an operating time of $t_{ae} < 40 \text{ s}$.

Response delay t_{on}

The response delay t_{on} is set uniformly for all alarm messages in the "t" menu using the parameter "ton", while each alarm message specified in the alarm assignment has its own timer for t_{on} . This delay can be used for interference suppression in the case of short measuring times.

An alarm message will only be signalled when a limit value of the respective measured value is violated for the duration of t_{on} . Each time the limit value is violated within the time t_{on} , the response delay "ton" restarts.

Total response time t_{an}

The total response time t_{an} is the sum of the operating time t_{ae} and the response delay t_{on} .

Delay on release t_{off}

The delay on release t_{off} can be set uniformly for all alarm messages using the parameter "toff", while each alarm message specified in the alarm assignment has its own timer for t_{off} .

An alarm message will be signalled until the limit value of the respective measured value is no longer violated (including hysteresis) for the duration of t_{off} without interruption. Each time a limit value is no longer violated during t_{off} , the delay on release "toff" restarts.

Start-up delay t

After connecting the supply voltage U_S , the alarm output is suppressed for the time set in parameter "t" (0...10 s).

2.3.8 Password protection (on, OFF)

If password protection is activated (on), settings can only be made after entering the password (0...999). For its activation, see chapter 4.7.

2.3.9 External test/reset button (T/R)

Functions

- Reset = press the external button $< 1.5 \text{ s}$
- Reset + self test = press the external button $> 1.5 \text{ s}$
- Stop measuring function = press and hold the external button



When the measuring function is stopped, the display shows "StP".

Stop mode can also be triggered via an interface command, and in this case it can only be reset via the interface.

Only one ISOMETER® may be controlled via an external test/reset button.

A galvanic parallel connection of several test or reset inputs for testing multiple insulation monitoring devices is not allowed.

2.3.10 Fault memory

Disabled (OFF)

The LEDs and relays signal the fault as long as it is detected.

Enabled (ON)

The LEDs and relays signal the fault until a reset is performed or the supply voltage U_s is disconnected.

2.3.11 History memory HIS

The history memory saves exclusively the measured values for the first fault. The history memory must first be cleared before new measured values can be saved.

The values checked in the table in section "Displaying measured values", page 21 can be saved.

2.3.12 Digital interface

The ISOMETER® uses the serial hardware interface RS-485 with the following protocols:

- **BMS**

The BMS protocol is an essential component of the Bender measuring device interface (BMS bus protocol). Data transmission generally makes use of ASCII characters.

- **Modbus RTU**

Modbus RTU is an application layer messaging protocol, and it provides master/slave communication between devices that are connected via bus systems and networks. Modbus RTU messages have a 16-bit CRC (cyclic redundant checksum), which guarantees reliability.

- **IsoData**

The ISOMETER® sends an ASCII data string with a cycle of approximately 1 second. Communication with the ISOMETER® in this mode is not possible, and no additional sender may be connected via the RS-485 bus cable. The ASCII data string for the ISOMETER® is described in chapter 5.4.



The IsoData protocol can be terminated by sending the command "Adr3" during a transmission pause of the ISOMETER®.

The parameter address, baud rate and parity for the interface protocols are configured in the "out" menu.



With "Adr = 0", the menu entries baud rate and parity are not shown in the menu and the IsoData protocol is activated.

With a valid bus address (i.e. not equal to 0), the menu item "baud rate" is displayed in the menu. The parameter value "---" for the baud rate indicates the activated BMS protocol. In this case, the baud rate for the BMS protocol is set to 9600 baud. If the baud rate is set unequal to "---", the Modbus protocol with configurable baud rate is activated.

3 Installation, connection and commissioning

3.1 Dimensions

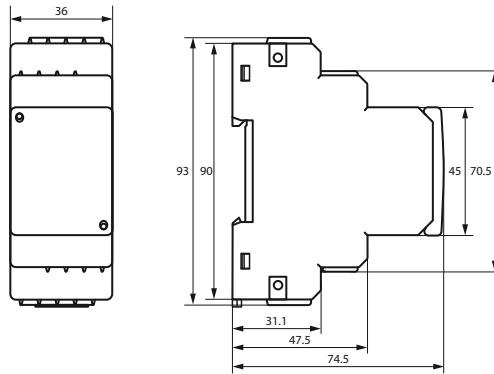

Figure: Dimension diagram (in mm)

3.2 Installation

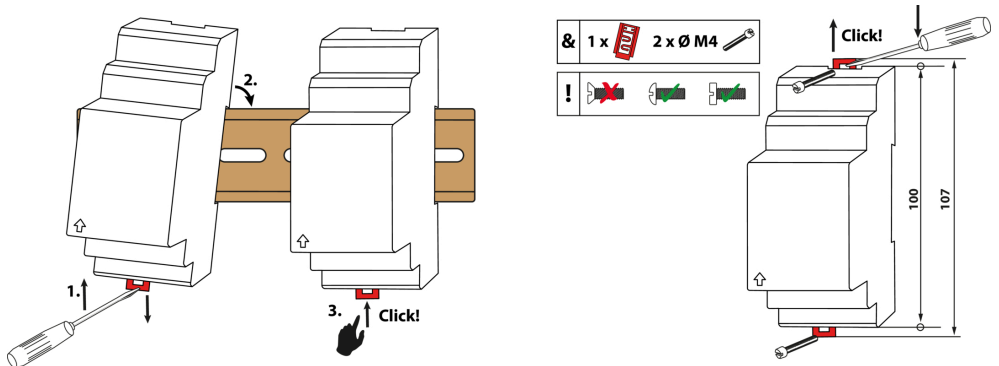

Figure: DIN rail mounting (left) or screw mounting (right)

3.3 Connection



DANGER Risk of fatal injury due to electric shock!

Touching live parts of the system carries the risk of:

- Risk of electrocution due to electric shock
- Damage to the electrical installation
- Destruction of the device

Before installing the device and before working on its connections, make sure that the installation has been de-energised. The rules for working on electrical systems must be observed.

For details about the conductor cross sections required for wiring, refer to chapter "6 Technical data".

Wiring diagram

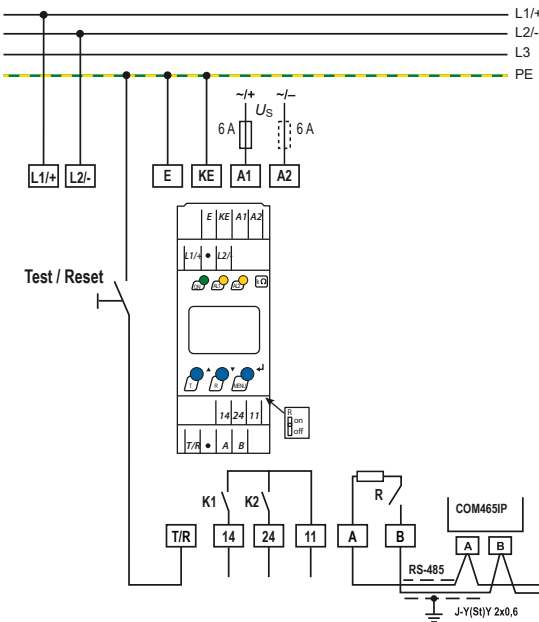

Terminal	Connections
A1, A2	Connection to the supply voltage U_s via fuse (line protection): If supplied from an IT system, protect both lines by a fuse.*
E, KE	Connect each terminal separately to PE: Use same wire cross section as for "A1", "A2".
L1/+, L2/-	Connection to the system to be monitored
T/R	Connection for the external combined test and reset button
11, 14	Connection to alarm relay "K1"
11, 24	Connection to alarm relay "K2"
A, B	RS-485 communication interface with connectable terminating resistor Example: Connection of a BMS Ethernet gateway COM465IP

Figure: Wiring diagram



*** For UL applications:**

Use 60/75 °C copper lines only!

For UL and CSA applications, connect the supply voltage U_s via 5 A fuses.

3.4 Commissioning

1. **Check that the ISOMETER® is properly connected to the system to be monitored.**
2. **Connect supply voltage U_s to the ISOMETER®.**

The device carries out a calibration, a self test and adjusts itself to the IT system to be monitored. With high system leakage capacitances this process may take up to 4 min. The standard display then appears showing the present insulation resistance, e.g.:



The pulse symbol  signals an error-free update of the resistance and capacitance measured values. If the measured value cannot be updated due to disturbances, the pulse symbol will be blanked.

3. **Start a manual self test** by pressing the test button "T" > 1.5 s. While holding the test button all available display elements are shown. After releasing the button, the test starts and "tES" flashes for the duration of the test. Detected malfunctions are displayed as error codes (see chapter 2.3.4.1).

i *The alarm relays are not checked during the test (factory setting). The setting can be changed in the "out" menu so that the relays switch to the alarm state during the manual self test.*

4. **Check if the settings are suitable for the system being monitored.**

The list of factory settings is shown in the tables from chapter 4.4.

i *For networks with a leakage capacitance > 5 μ F, the response value R_{an1} should be set to a maximum of 200 k Ω due to the increased measurement tolerance.*

5. **Check the functionality by a real insulation fault.**







Use a suitable resistor to check the ISOMETER® against earth in the system being monitored.

4 Operation

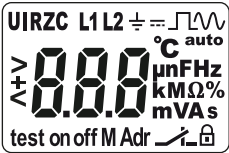
4.1 Operating and display elements

Device front	Operating elements	Function
<p>The diagram shows the front panel of the device. At the top, there are three LEDs labeled ON (green), AL1 (yellow), and AL2 (yellow). Below them is a large rectangular display area. At the bottom, there are three buttons labeled T, R, and MENU. The T button has an upward-pointing triangle above it. The R button has a downward-pointing triangle above it. The MENU button has a left-pointing arrow above it. A legend at the bottom left indicates that a solid circle represents 'LED on' and a circle with a dot represents 'LED flashes'.</p>	ON	Power LED
	AL1 AL2	Alarm LEDs (For codes see “Assigning the alarm messages to the relays”, page 23.)
	▲▼	Up and down buttons – For navigating up or down in the menu settings. – For increasing or decreasing values.
	T	Test button (press > 1.5 s)
	R	Reset button (press > 1.5 s)
	↵	Enter button – Select menu item. – Save value.
	MENU	MENU button (press > 1.5 s) – Starts menu mode. – Exits menu item without saving changes.

- LED on
- ⊙ LED flashes

Display	Display elements	Function
	U	System voltage U_n
	R	Insulation resistance R_F
	Z	Impedance Z_F
	C	System leakage capacitance C_e
	L1 L2 	Monitored conductors
		Voltage type DC
		Pulse symbol: error-free measured value update
		Voltage type AC
	°C μ n F Hz k M Ω % m V A s	Measured values and units
		Password protection is activated
		In the menu mode, the operating mode of the respective alarm relay is displayed.
	Adr	Communication interface with measured value: isoData operation
	M	Fault memory is activated
	on / off	Condition symbols
	test	Self test is active
	> + <	Identification for response values and response value violation

i

The display parameters that can be configured flash.

The readability below -25 °C is limited.

Depending on the ISOMETER®'s scope of functions, not all display elements are used.



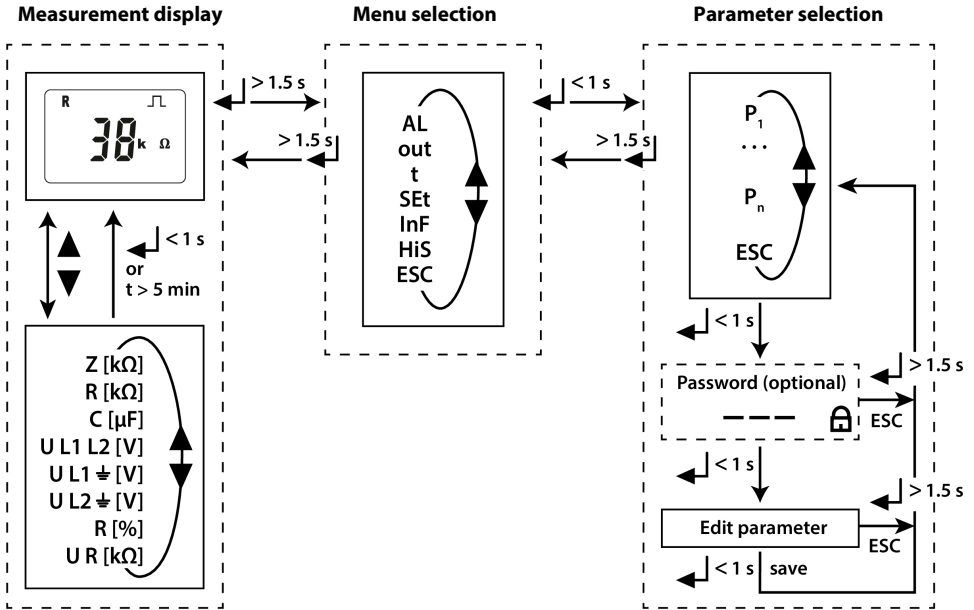



4.2 Menu overview



Menu item	Parameter
AL	Querying and setting response values
out	Configuring fault memory, alarm relays and interface
t	Setting delay times and self test cycles
SEt	Setting device control parameters
InF	Querying software version
HiS	Querying and clearing the history memory
ESC	Going to the next-higher menu level

4.3 Displaying measured values

Overview

HiS	Display	Description
✓	Z kΩ 	Insulation impedance Z_F 1 kΩ ... 1 MΩ
✓	± R kΩ 	Insulation resistance R_F 1 kΩ ... 4 MΩ
✓	C μF 	System leakage capacitance C_e Z mode = off: 1 μF ... 400 μF Z mode = on: 1 nF ... 5 μF
✓	~ ± U L1 L2 V	System voltage U_n (L1 - L2) 0 V _{RMS} ... 500 V _{RMS}
✓	± U L1  = V	Residual voltage U_{L1e} (L1/+ - PE) DC 0...500 V
✓	± U L2  = V	Residual voltage U_{L2e} (L2/- - PE) DC 0...500 V
✓	± R %	Fault location in % -100 % ... +100 % Displayed if $U_n \geq$ DC 20 V $R_{L1F} = (200 \% \times R_F) / (100 \% + x \%)$ $R_{L2F} = (200 \% \times R_F) / (100 \% - x \%)$
-	U R = kΩ 	Insulation resistance R 1 kΩ ... 4 MΩ Displayed if $U_n \geq$ DC 20 V Approximate value for asymmetrical insulation faults that can be used as a trend indicator with short measuring times. Not available in Z mode.

✓ The measured value is displayed in the history memory.

Displaying the current measured values

The standard display shows the currently measured value for R_F in R mode or Z_F in Z mode. Press the up or down buttons to display the other measured values. After 5 min at the latest the display switches back to the standard display.



ADVICE

The pulse symbol indicates a currently measured value. If this symbol does not appear, the measurement is still ongoing and the latest valid measured value will be displayed. The symbols "<" or ">" will be displayed additionally to the measured value when a response value has been reached or violated, or the measured value is below or above the measuring range.

4.4 Setting the response values (AL)

4.4.1 Setting the response values for monitoring the insulation resistance (R mode) or the insulation impedance (Z mode)

How to proceed

1. Open menu "AL".
2. Select parameter "R1" / "Z1" for prewarning or parameter "R2" / "Z2" for alarm.
3. Set value and confirm with Enter.

4.4.2 Setting the response values for undervoltage and overvoltage

How to proceed

1. Open menu "AL".
2. Select parameter "U<" for undervoltage or parameter "U>" for overvoltage.
3. Set value and confirm with Enter.

4.4.3 Response values overview

Display	Activation		Setting value			Description
	FAC	Cs	Range	FAC	Cs	
R1 <	on		R2 ... 990	40	kΩ	Prewarning value R_{an1} Hys. = 25 % / min. 1 kΩ
R2 <	on		1 ... R1	10	kΩ	Alarm value R_{an2} Hys. = 25 % / min. 1 kΩ
Z1 <	off		Z2 ... 500	60	kΩ	Prewarning value Z_{an1} Hys. = 25 % / min. 1 kΩ
Z2 <	off		10 ... Z1	50	kΩ	Alarm value Z_{an2} Hys. = 25 % / min. 1 kΩ
U <	off		10 ... U>	30	V	Alarm value undervoltage Hys. = 5 % / min. 5 V
U >	off		U< ... 500	500	V	Alarm value overvoltage Hys. = 5 % / min. 5 V



FAC Factory settings

Cs Customer settings

4.5 Configuring fault memory, alarm relays, and interfaces (out)

Call up menu „out“ to configure fault memory, alarm relays, and interfaces.

4.5.1 Configuring the relays

Relay K1			Relay K2			Description
Display	FAC	Cs	Display	FAC	Cs	
 1	n/c		 2	n/c		Relay operating mode n/c or n/o



FAC Factory settings

Cs Customer settings

4.5.2 Assigning the alarm messages to the relays

The “on” setting assigns an alarm message to the respective relay. The LED indication is directly assigned to the alarm message and is not related to the relays.

In the event of an unsymmetrical insulation fault, only the alarm message corresponding to the assigned conductor (L1/+ or L2/-) will be displayed.

K1 “r1”			K2 “r2”			LEDs			Description
Display	FAC	Cs	Display	FAC	Cs	ON	AL1	AL2	
 1 Err	off		 2 Err	on		⊙	⊙	⊙	Device error E:xx
r1 +R1 < Ω	on		r2 +R1 < Ω	off		●	●	○	Prewarning R1 Fault R_f at L1/+
r1 -R1 < Ω	on		r2 -R1 < Ω	off		●	●	○	Prewarning R1 Fault R_f at L2/-
r1 +R2 < Ω	off		r2 +R2 < Ω	on		●	○	●	Alarm R2 Fault R_f at L1/+
r1 -R2 < Ω	off		r2 -R2 < Ω	on		●	○	●	Alarm R2 Fault R_f at L2/-
r1 Z1 < Ω	on		r2 Z1 < Ω	off		●	●	○	Prewarning Z1
r1 Z2 < Ω	off		r2 Z2 < Ω	on		●	○	●	Alarm Z2
r1 U < V	off		r2 U < V	on		●	○	⊙	Alarm U_n Undervoltage
r1 U > V	off		r2 U > V	on		●	⊙	○	Alarm U_n Overvoltage

K1 "r1"			K2 "r2"			LEDs			Description
Display	FAC	Cs	Display	FAC	Cs	ON	AL1	AL2	
r1 test	off		r2 test	off		●	●	●	Manually started device test
r1 S.AL	off		r2 S.AL	off		●	●	●	Device start with alarm

- FAC Factory settings
- Cs Customer settings
- LED off
- ⊙ LED flashes
- LED on

4.5.3 Activating or deactivating fault memory

Display	FAC	Cs	Description
M	off		Memory function for alarm messages (fault memory)

- FAC Factory settings
- Cs Customer settings

4.5.4 Configuring interface

Display	Setting value				Description
	Range	FAC	Cs		
Adr	0 / 3...90	3	()	Bus Adr.	Adr = 0 deactivates BMS as well as Modbus and activates isoData with continuous data output (115k2, 8E1)
Adr 1	--- 1.2k...115k	"---"	()	Baud rate	"---": BMS bus (9k6, 7E1) "1.2k" ... "115k": Modbus (variable)
Adr 2	8E1 8o1 8n1 8n2	8E1	()	Modbus	8E1 - 8 data bits, even parity, 1 stop bit 8o1 - 8 data bits, odd parity, 1 stop bit 8n1 - 8 data bits, no parity, 1 stop bit 8n2 - 8 data bits, no parity, 2 stop bits

- FAC Factory settings
- Cs Customer settings
- () Customer setting that is not modified by FAC.

i Adr 2 can only be selected, if Adr 1 is not "---".

4.6 Setting delay times and self test cycles (t)

Open menu "t" to configure the times.

Display	Setting value			Description
	Range	FAC	Cs	
t	0...10	0	s	Start-up delay when starting the device
ton	0...99	0	s	Response delay K1 and K2
toff	0...99	0	s	Delay on release K1 and K2
test	OFF/1/24	24	h	Repetition time for device test

FAC Factory settings

Cs Customer settings

4.7 Setting device control parameters (SEt)

Open menu "SEt" to configure the device control.

Display	Activation		Setting value			Description
	FAC	Cs	Range	FAC	Cs	
	off		0..999	0		Password for parameter setting
Z	off		50.0 60.0	50.0	Hz	Z mode: Activate impedance calculation Z_f and select corresponding system frequency f_n
nEt	on					System connection test
S.Ct	on					Device test at device start
FAC						Restore factory settings
SYS						For Bender Service only

FAC Factory settings

Cs Customer settings

4.8 Reset to factory settings

All settings with the exception of the interface parameters are reset to the factory settings.

1. Press MENU button (> 1.5 s).
2. Go to "SEt" and confirm with Enter.
3. Go to "FAC" and confirm with Enter.

4.9 Showing and deleting the history memory



ADVICE

The history memory saves the measured values for the first fault only. To this end, the history memory must be empty.



ADVICE

The fault location is only written to the history memory in R mode and Z_F only in Z mode.

Show history memory

Call up "HiS" menu and go up or down.

Delete history memory

Call up "HiS" menu, go to "Clr" and confirm.

4.10 Querying software version (InF)

The software version is displayed as a ticker. Afterwards it can be output step by step using the up or down buttons.

How to proceed

1. Press MENU button (> 1.5 s).
2. Go to "InF" and confirm with Enter.
3. If necessary, use up or down buttons to display it step by step.

5 Data access via RS-485 interface

5.1 Data access using the BMS protocol

The BMS protocol is an essential component of the Bender measuring device interface (BMS bus protocol). Data transmission generally makes use of ASCII characters.

BMS channel no.	Operation value	Alarm
1	R_F	Prewarning R1
2	R_F	Alarm R2
3	Z_F	Alarm Z2
4	U_n	Undervoltage
5	U_n	Overvoltage
6		Connection fault, earth (E.01)
7		Connection fault, system (E.02)
8		All other device faults (E.xx)
9	Fault location [%]	
10	C_e	
11	Z_F	Prewarning Z1
12	Update counter	
13	U_{L1e}	
14	U_{L2e}	
15	R_{UGF}	

5.2 Data access using the Modbus RTU protocol

Requests to the ISOMETER® can be made using the function code 0x03 (read multiple registers) or the command 0x10 (write multiple registers). The ISOMETER® generates a function-related answer and sends it back.

5.2.1 Reading out the Modbus register from the ISOMETER®

The required Words of the process image can be read out from the ISOMETER® “Holding Registers” using function code 0x03. For this purpose, the start address and the number of the registers to be read out must be entered. Up to 125 Words (0x7D) can be read out with one single request.

Command of the master to the ISOMETER®

In the following example, the master of the ISOMETER® requests the content of register 1003 using address 3. The register contains the channel description of measuring channel 1.

Byte	Name	Example
Byte 0	ISOMETER® Modbus address	0x03
Byte 1	Function code	0x03
Byte 2, 3	Start address	0x03EB
Byte 4, 5	Number of registers	0x0001
Byte 6, 7	CRC16 checksum	0xF598

Answer of the ISOMETER® to the master

Byte	Name	Example
Byte 0	ISOMETER® Modbus address	0x03
Byte 1	Function code	0x03
Byte 2	Number of data bytes	0x02
Byte 3, 4	Data	0x0047
Byte 7, 8	CRC16 checksum	0x81B6

5.2.2 Writing the Modbus register (parameter setting)

Registers in the device can be modified with function code 0x10 (set multiple registers). Parameter registers start with address 3000. For the contents of the registers, see table in chapter 5.3.2.1.

The master sends a command to the ISOMETER®

In this example, address 3 is used to set the content of register address 3003 to 2.

Byte	Name	Example
Byte 0	ISOMETER® Modbus address	0x03
Byte 1	Function code	0x10
Byte 2, 3	Start register	0x0BBB
Byte 4, 5	Number of registers	0x0001
Byte 6	Number of data bytes	0x02
Byte 7, 8	Data	0x0002
Byte 9, 10	CRC16 checksum	0x9F7A

Response of the ISOMETER® to the master

Byte	Name	Example
Byte 0	ISOMETER® Modbus address	0x03
Byte 1	Function code	0x10
Byte 2, 3	Start register	0x0BBB
Byte 4, 5	Number of registers	0x0001
Byte 6, 7	CRC16 checksum	0x722A

5.2.3 Exception code

If the ISOMETER® cannot respond to a request, it will send an exception code with which possible faults can be narrowed down.

Exception code	Description
0x01	Impermissible function
0x02	Impermissible data access
0x03	Impermissible data value
0x04	Internal fault
0x05	Acknowledgement of receipt (answer will be time-delayed)
0x06	Request not accepted (repeat request if necessary)

Structure of the exception code

Byte	Name	Example
Byte 0	ISOMETER® Modbus address	0x03
Byte 1	Function code (0x03) + 0x80	0x83
Byte 2	Data (exception code)	0x04
Byte 3, 4	CRC16 checksum	0xE133

5.3 Modbus register assignment

5.3.1 Modbus measured value registers

Depending on the device condition, the information in the registers is the measured value without alarm, the measured value with alarm 1, the measured value with alarm 2, or the device error. For more information see , page 31.

Register	Measured value			Device error
	Without alarm	Alarm 1 [prewarning]	Alarm 2 [alarm]	
1000...1003	R_F Insulation fault (71)	R_F Insulation fault (1)	R_F Insulation fault (1)	Earth connection (102)
1004...1007	Z_F Insulation fault (86)	Z_F Insulation fault (86)	Z_F Insulation fault (86)	
1008...1011	U_n Voltage (76)	U_n Overvoltage (78)	U_n Undervoltage (77)	Connection to system (101)
1012...1015	C_e Capacitance (82)			
1016...1019	U_{L1e} Voltage (76)			
1020...1023	U_{L2e} Voltage (76)			
1024...1027	Fault location in % (1022)			
1028...1031	R_{UGF} Insulation fault (71)			
1032...1035	Measured value update counter (1022)			Device error (115)

() channel description code (see "Channel descriptions", page 33)

5.3.1.1 Measurement coding

Each measured value is available as a channel and consists of 8 bytes (4 registers). The first measured value register address is 1000. The structure of a channel is always the same. Content and number depend on the device. The structure of a channel is shown with the example of channel 1:

1000		1001		1002		1003	
HiByte	LoByte	HiByte	LoByte	HiByte	LoByte	HiByte	LoByte
Floating point value (Float)				Alarm type and test type (AT&T)	Range and unit (R&U)	Channel description	

5.3.1.2 Float = Floating point value of the channels

Representation of the bit order for processing analogue measured values according to IEEE 754

Word	0x00																0x01															
Byte	HiByte								LoByte								HiByte								LoByte							
Bit	31	30	29	28	27	26	25	24	23	22	21	20	19	18	17	16	15	14	13	12	11	10	9	8	7	6	5	4	3	2	1	0
	S	E	E	E	E	E	E	E	E	E	M	M	M	M	M	M	M	M	M	M	M	M	M	M	M	M	M	M	M	M	M	M

E exponent
 M mantissa
 S sign

5.3.1.3 AT&T = Alarm type and test type (internal/external)

Bit	7	6	5	4	3	2	1	0	Meaning
	Test external	Test internal	Reserved	Reserved	Reserved	Alarm	Fault		
Alarm type	X	X	X	X	X	0	0	0	No alarm
	X	X	X	X	X	0	0	1	Prewarning
	0	0	X	X	X	0	1	0	Device error
	X	X	X	X	X	0	1	1	Reserved
	X	X	X	X	X	1	0	0	Warning
	X	X	X	X	X	1	0	1	Alarm
	X	X	X	X	X	1	1	0	Reserved
	X	X	X	X	X	1	1	1	Reserved
Test	0	0	X	X	X	X	X	X	No test
	0	1	X	X	X	X	X	X	Internal test
	1	0	X	X	X	X	X	X	External test

- Bits 0 to 2: coding for the alarm type
- Bits 3 to 5: reserved; value 0
- Bit 6 oder 7: set when an internal or external test is active

Other values are reserved. The complete byte is calculated from the sum of the alarm type and the test type.

5.3.1.4 R&U = Range and unit

Bit	7	6	5	4	3	2	1	0	Meaning
Unit	-	-	-	0	0	0	0	0	Invalid (init)
	-	-	-	0	0	0	0	1	No unit
	-	-	-	0	0	0	1	0	Ω
	-	-	-	0	0	0	1	1	A
	-	-	-	0	0	1	0	0	V
	-	-	-	0	0	1	0	1	%
	-	-	-	0	0	1	1	0	Hz
	-	-	-	0	0	1	1	1	Baud
	-	-	-	0	1	0	0	0	F
	-	-	-	0	1	0	0	1	H
	-	-	-	0	1	0	1	0	°C
	-	-	-	0	1	0	1	1	°F
	-	-	-	0	1	1	0	0	Second
	-	-	-	0	1	1	0	1	Minute
	-	-	-	0	1	1	1	0	Hour
-	-	-	0	1	1	1	1	Day	
-	-	-	1	0	0	0	0	Month	
Range of validity	0	0	X	X	X	X	X	X	Actual value
	0	1	X	X	X	X	X	X	The actual value is lower
	1	0	X	X	X	X	X	X	The actual value is higher
	1	1	X	X	X	X	X	X	Invalid value

- Bits 0 to 4: coding for the unit
- Bits 6 and 7: validity range of a value
- Bit 5: reserved

The complete byte is calculated from the sum of the unit and the range of validity.

5.3.1.5 Channel descriptions

Value	Description of measured value / message	Comments
0		
1 (0x01)	Insulation fault	
71 (0x47)	Insulation fault	Insulation resistance R_F in Ω
76 (0x4C)	Voltage	Measured value in V
77 (0x4D)	Undervoltage	
78 (0x4E)	Overvoltage	
82 (0x52)	Capacitance	Measured value in F
86 (0x56)	Insulation fault	Impedance Z_i
101 (0x65)	System connection	
102 (0x66)	Earth connection	
115 (0x73)	Device error	ISOMETER® fault
129 (0x81)	Device error	
145 (0x91)	Own address	

5.3.2 Modbus parameter register

5.3.2.1 Parameter coding

Register	Property	Description	Format	Unit	Value range
999	RO	Number of Modbus measured-value channels with active alarm	UINT 16		0...9
3000	RW	Activation prewarning value for impedance measurement "Z1"	UINT 16		[2]/[3] *
3001	RW	Prewarning value for impedance measurement, "Z1"	UINT 16	k Ω	Z2 ... 500
3002	RW	Activation alarm value for impedance measurement, "Z2"	UINT 16		[2]/[3] *
3003	RW	Alarm value for impedance measurement, "Z2"	UINT 16	k Ω	10 ... Z1
3004	RW	Activation prewarning value resistance measurement "R1"	UINT 16		0/1/[2]/[3] *
3005	RW	Prewarning value resistance measurement "R1"	UINT 16	k Ω	R2 ... 990
3006	RW	Activation alarm value resistance measurement "R2"	UINT 16		0/1/[2]/[3] *

Register	Property	Description	Format	Unit	Value range
3007	RW	Alarm value resistance measurement "R2"	UINT 16	kΩ	1 ... R1
3008	RW	Activation alarm value undervoltage "U<"	UINT 16		0 = off 1 = on
3009	RW	Alarm value undervoltage "U<"	UINT 16	V	10 ... U>
3010	RW	Activation alarm value overvoltage "U>"	UINT 16		0 = off 1 = on
3011	RW	Alarm value overvoltage "U>"	UINT 16	V	U< ... 500
3012	RW	Memory function for alarm messages (fault memory) "M"	UINT 16		0 = off 1 = on
3013	RW	Operating mode of relay K1 "r1"	UINT 16		0 = n/o 1 = n/c
3014	RW	Operating mode of relay K2 "r2"	UINT 16		0 = n/o 1 = n/c
3015	RW	Bus address "Adr"	UINT 16		0 / 3 ... 90
3016	RW	Baud rate "Adr 1"	UINT 16		0 = BMS 1 = 1.2 k 2 = 2.4 k 3 = 4.8 k 4 = 9.6 k 5 = 19.2 k 6 = 38.4 k 7 = 57.6 k 8 = 115.2 k
3017	RW	Parity "Adr 2"	UINT 16		0 = 8N1 1 = 8O1 2 = 8E1 3 = 8N2
3018	RW	Start-up delay "t" during device start	UINT 16	s	0 ... 10
3019	RW	Response delay "ton" for relays "K1" and "K2"	UINT 16	s	0 ... 99
3020	RW	Delay on release "toff" for relays "K1" and "K2"	UINT 16	s	0 ... 99
3021	RW	Repetition time "test" for automatic device test	UINT 16		0 = off 1 = 1 h 2 = 24 h
3022	RW	Parameter "Z": activating Z mode for impedance calculation	UINT 16		0 = off 1 = on
3023	RW	Parameter "Z": system frequency f_n for Z mode	UINT 16		500 = 50.0 Hz 600 = 60.0 Hz

Register	Property	Description	Format	Unit	Value range
3024	RW	Test of the system connection during device test "nEt"	UINT 16		0 = off 1 = on
3025	RW	Device test during device start "S.Ct"	UINT 16		0 = off 1 = on
3026	RW	Request stop mode (0 = deactivate devices)	UINT 16		0 = Stop 1 = ---
3027	RW	Alarm assignment of relay K1 "r1"	UINT 16		Bit 11 ... Bit 1
3028	RW	Alarm assignment of relay K2 "r2"	UINT 16		Bit 11 ... Bit 1
8003	WO	Factory settings for all parameters	UINT 16		0x6661 "fa"
8004	WO	Factory setting only for parameters resettable by FAC	UINT 16		0x4653 "FS"
8005	WO	Start device test	UINT 16		0x5445 "TE"
8006	WO	Clear fault memory	UINT 16		0x434C "CL"
9800 ... 9809	RO	Device name (ASCII)	UNIT 16		
9820	RO	Software identification number	UINT 16		
9821	RO	Software version number	UINT 16		
9822	RO	Software version: Year	UINT 16		
9823	RO	Software version: Month	UINT 16		
9824	RO	Software version: Day	UINT 16		
9825	RO	Modbus driver version	UINT 16		

RO Read only

RW Read/Write

WO Write only

* The values [2] and [3] can neither be changed nor set by the operator. 0/[2] = off; 1/[3] = on

5.3.2.2 Alarm assignment of the relays

Several messages and alarms can be assigned to each relay. For the assignment to each relay, a 16-bit register is used with the bits described below. The following table applies to relay K1 and relay K2, in which "x" stands for the relay number. A set bit activates the specified function.

Bit	Display indication	Meaning
0	Reserved	When reading: 0 When writing: any value
1	 x Err	Device error E.xx
2	rx +R1 < Ω	Prewarning R1 - Fault R_f at L1/+

Bit	Display indication	Meaning
3	rx -R1 < Ω	Prewarning R1 - Fault R_f at L2/-
4	rx +R2 < Ω	Alarm R2 - Fault R_f at L1/+
5	rx -R2 < Ω	Alarm R2 - Fault R_f at L2/-
6	rx Z1 < Ω	Prewarning Z1
7	rx Z2 < Ω	Alarm Z2
8	rx U < V	Alarm message U_n - Undervoltage
9	rx U > V	Alarm message U_n - Overvoltage
10	rx test	Manually started self test
11	rx S.AL	Device start with alarm
12...15	Reserved	When reading: 0 When writing: any value

5.3.2.3 Device name

The data format of the device name consists of ten Words with two ASCII characters each.

0x00	0x01	0x02	0x03	0x04	0x05	0x06	0x07	0x08	0x09
------	------	------	------	------	------	------	------	------	------

5.4 IsoData data string

In IsoData mode the ISOMETER® sends the entire data string roughly once per second. Communication with the ISOMETER® in this mode is not possible and no additional sender may be connected via the RS-485 bus cable.

IsoData is activated in the menu “out”, menu item “Adr”, when Adr is set to 0. In this case, the “Adr” symbol flashes on the measured value display.

String	Description
!;	Start symbol
v;	Insulation fault location “ ” / “+” / “-”
1234, 5;	Insulation resistance R_f [k Ω]
1234;	System leakage capacitance C_e ; R mode [μ F] / Z mode [nF]
1234, 5;	Insulation impedance Z_f [k Ω]
+1234;	System voltage U_n [V _{RMS}] System voltage type: AC or unknown: “ ” DC: “+” / “-”
+1234;	Residual DC voltage U_{L1e} [V]
+1234;	Residual DC voltage U_{L2e} [V]
+123;	Insulation fault location -100 ... +100 [%]
1234, 5;	Approximate unsymmetrical insulation resistance R_{UGf} [k Ω]
1234;	Alarm message [hexadecimal] (without leading “0x”) The alarms are included in this value with the OR function. Assignment of the alarms: 0x0002 device error 0x0004 Prewarning insulation resistance R_f at L1/+ 0x0008 Prewarning insulation resistance R_f at L2/- 0x000C Prewarning insulation resistance R_f symmetrical 0x0010 Alarm insulation resistance R_f at L1/+ 0x0020 Alarm insulation resistance R_f at L2/- 0x0030 Alarm insulation resistance R_f symmetrical 0x0040 Prewarning insulation impedance Z_f 0x0080 Alarm insulation impedance Z_f 0x0100 Alarm message undervoltage U_n 0x0200 Alarm message overvoltage U_n 0x0400 Manually started self test 0x0800 Device start with alarm
1;	Update counter, consecutively counts from 0 to 9. It increases with the update of the insulation resistance value.

String	Description
<CR><LF>	String end

6 Technical data

6.1 Technical data isoMIL425

()* = factory setting

Insulation coordination acc. to IEC 60664-1/-3

Definitions

Measuring circuit (IC1)	L1/+, L2/-
Supply circuit (IC2)	A1, A2
Output circuit (IC3)	11, 14, 24
Control circuit (IC4)	E, KE, T/R, A, B
Rated voltage	400 V
Overvoltage category	III

Rated impulse voltage

IC1/(IC2-4)	6 kV
IC2/(IC3-4)	4 kV
IC3/(IC4)	4 kV
Pollution degree	3

Rated insulation voltage

IC1/(IC2-4)	400 V
IC2/(IC3-4)	250 V
IC3/(IC4)	250 V
Pollution degree	3

Protective separation (reinforced insulation) between

IC1/(IC2-4)	Overvoltage category III, 600 V
IC2/(IC3-4)	Overvoltage category III, 300 V
IC3/(IC4)	Overvoltage category III, 300 V

Voltage test (routine test) according to IEC 61010-1

IC2/(IC3-4)	AC 2.2 kV
IC3/(IC4)	AC 2.2 kV

Supply voltage

Supply voltage U_s	AC 100...240 V DC 24...240 V
Tolerance of U_s	-30...+15 %
Frequency range of U_s	47...63 Hz
Power consumption	$\leq 3 \text{ W}, \leq 9 \text{ VA}$

Monitored IT system

Nominal system voltage U_n	3(N)AC, AC/DC 0...400 V
Tolerance of U_n	+25 %
Frequency range of U_n	DC, 15...460 Hz

Measuring circuit

Measuring voltage U_m	$\pm 12 \text{ V}$
Measuring current I_m at $R_F, Z_F = 0 \Omega$	$\leq 110 \mu\text{A}$
Internal resistance R_{iF}, Z_i	$\geq 115 \text{ k}\Omega$
Permissible system leakage capacitance C_e	R mode: $\leq 300 \mu\text{F}$ Z mode: $\leq 1 \mu\text{F}$
Permissible extraneous DC voltage U_{fg}	$\leq 700 \text{ V}$

Response values

Response value R_{an1}	2...990 k Ω (40 k Ω)*
Response value R_{an2}	1...980 k Ω (10 k Ω)*
Relative uncertainty R_{an} (R mode or $Z_F \approx R_F$)	$\pm 15 \%$, at least $\pm 1 \text{ k}\Omega$
Hysteresis R_{an}	25 %, at least 1 k Ω
Response value Z_{an1}	11...500 k Ω (off)*
Response value Z_{an2}	10...490 k Ω (off)*
Relative uncertainty Z_{an}	$\pm 15 \%$, at least $\pm 1 \text{ k}\Omega$
Hysteresis Z_{an}	25 %, at least 1 k Ω
Undervoltage detection	10...499 V (off)*
Overvoltage detection	11...500 V (off)*
Relative uncertainty U	$\pm 5 \%$, at least $\pm 5 \text{ V}$

Relative uncertainty depending on the frequency ≥ 400 Hz	-0,015 %/Hz
Hysteresis U	5 %, at least 5 V

Time response

Response time t_{an} of $R_F = 0.5 \times R_{an}$ and $C_e = 1 \mu\text{F}$ nach IEC 61557-8	≤ 10 s
Response time t_{an} of $Z_F = 0.5 \times Z_{an}$	≤ 5 s
Start-up delay t	0...10 s (0 s)*
Response delay t_{on}	0...99 s (0 s)*
Delay on release t_{off}	0...99 s (0 s)*

Displays, memory

Display	LC display, multi-functional, not illuminated
Display range measured value insulation resistance (R_F)	1 k Ω ... 4 M Ω
Display range measured value impedance (Z_F) with $f_n = 50/60$ Hz	1 k Ω ... 1 M Ω
Operating uncertainty (R_F in R mode, Z_F in Z mode)	± 15 %, at least ± 1 k Ω
Display range measured value nominal system voltage (U_n)	0...500 V _{RMS}
Operating uncertainty	± 5 %, at least ± 5 V
Display range measured value system leakage capacitance of $R_F > 10$ k Ω	0...300 μF
Operating uncertainty	± 15 %, at least ± 2 μF
Display range measured value system leakage capacitance of $Z_F > 10$ k Ω	1 nF ... 1 μF
Operating uncertainty ($Z_F \approx X_C$)	± 15 %, at least ± 2 nF
Password	off / 0...999 (off, 0)*
Fault memory alarm messages	on / (off)*

Interface

Interface; protocol	RS-485; BMS, Modbus RTU, isoData
Baud rate	BMS (9.6 kBit/s), Modbus RTU (selectable), isoData (115.2 kBit/s)
Cable length (9,6 kBit/s)	≤ 1200 m
Cable: twisted pairs, shield connected to PE on one side	min. J-Y(St)Y 2 \times 0.6
Terminating resistor	120 Ω (0.25 W), internal, can be connected

Device address, BMS bus, Modbus RTU	3...90 (3)*
-------------------------------------	-------------

Switching elements

Switching elements	2 × 1 n/o contacts, common terminal 11
Operating principle	n/c, n/o (n/o)*
Electrical endurance	10,000 cycles

Contact data acc. to IEC 60947-5-1

Utilisation category	AC-12 / AC-14 / DC-12 / DC-12 / DC-12
Rated operational voltage	230 V / 230 V / 24 V / 110 V / 220 V
Rated operational current	5 A / 2 A / 1 A / 0,2 A / 0,1 A
Necessary minimum contact load	1 mA at AC/DC ≥ 10 V

Environment/EMC

EMC	IEC 61326-2-4, DIN EN 50121-3-2
-----	---------------------------------

Ambient temperatures

Operation	-40...+70 °C
Transport	-50...+85 °C
Storage	-55...+80 °C

Climatic class acc. to IEC 60721

Stationary use (IEC 60721-3-3)	3K24
Transport (IEC 60721-3-2)	2K11
Long-time storage (IEC 60721-3-1)	1K23

Classification of mechanical conditions acc. to IEC 60721

Stationary use (IEC 60721-3-3)	3M12
Transport (IEC 60721-3-2)	2M4
Long-time storage (IEC 60721-3-1)	1M12

Other

Operating mode	continuous operation
Mounting	cooling slots must be ventilated vertically
Degree of protection, built-in components (DIN EN 60529)	IP30
Degree of protection, terminals (DIN EN 60529)	IP20

Enclosure material	polycarbonate
DIN rail mounting acc. to	IEC 60715
Screw mounting	2 × M4 with mounting clip
Weight	≤ 150 g

6.2 Connection

Push-wire terminals

Nominal current	≤ 10 A
Conductor sizes	AWG 24...14
Stripping length	10 mm
Rigid	0.2...2.5 mm ²
Flexible without ferrules	0.75...2.5 mm ²
Flexible with ferrules with/without plastic sleeve	0.25...2.5 mm ²
Multi-conductor flexible with TWIN ferrules with plastic sleeve	0.5...1.5 mm ²
Opening force	50 N
Test opening	Ø 2.1 mm

6.3 Standards and certifications

The ISOMETER® was developed in compliance with the standards specified in the Declaration of Conformity.



EU Declaration of Conformity

Hereby, Bender GmbH & Co. KG declares that the device covered by the Radio Directive complies with Directive 2014/53/EU. The full text of the EU Declaration of Conformity is available at the following Internet address:



https://www.bender.de/fileadmin/content/Products/CE/CEKO_isoXX425.pdf

UKCA Declaration of Conformity

Hereby, Bender GmbH & Co. KG declares that this device is in compliance with Radio Equipment Regulations 2017 (S.I. 2017/1206). The full text of the UK declaration of conformity is available at the following internet address:



https://www.bender.de/fileadmin/content/Products/UKCA/UKCA_isoXX425.pdf

6.4 Ordering data

ISOMETER®

Model	Supply voltage U_s	Article number	
		Push-wire terminals	Screw-type terminals
isoMIL425-D4W-4	AC 100...240 V; 47...63 Hz DC 24...240 V	B71036306W	

Accessories

Description	Article number
Mounting clip for screw mounting	B98060008

6.5 Change log

Date	Document version	Valid from software version	State/Changes
04.2015	00	D0459 V1.xx	First edition
02.2017	01	D0459 V1.xx	Addition Chapter 1 and Chapter 2.1 Chapter 4.1 : Dimension diagram screw mounting (116 mm --> 107 mm) Chapter 10.1 : Section „Insulation coordination acc. to IEC 60664-1/IEC 60664-3“, information „push-wire terminal“ in section „Connection“
05.2018	02	D0459 V1.xx	Chapter 10.2 : Standard DIN EN 50155:2014-12 deleted
03.2019	03	D0459 V1.xx	Chapter 4.1 : Dimension diagram, screw mounting, DIN rail mounting Chapter 5.4.4 : Parity 8n2 Chapter 8: Modbus register 999 added, registers 3000, 3002, 3004, 3006, 3008, 3010, 3012, value range 3017 (3 = 8N2), 3022, 3024, 3025, note * added

Date	Document version	Valid from software version	State/Changes
02.2021	04	D0459 V1.xx	<i>Editorial revision</i> Chapter 2.3: Intended use Chapter 3.2.10: Note on stopped measuring function added Chapter 4.2: Wiring diagram Chapter 5.2: Menu overview representation Chapter 10.1: Term „Necessary minimum contact load“, climatic/ mechanical classifications Chapter 10.2 : Logo UKCA
09.2023	05	D0459 V1.xx	Editorial revision <ul style="list-style-type: none">• Transfer to SMC incl. new CI and new chapter structure• Better separation of descriptive and instructional texts (function/operation) Modbus register assignment 1009-1010: undervoltage and overvoltage swapped. Standards: Link to website added.



Bender GmbH & Co. KG

Londorfer Straße 65
35305 Grünberg
Germany

Tel.: +49 6401 807-0
info@bender.de
www.bender.de

Alle Rechte vorbehalten.
Nachdruck und Vervielfältigung nur mit
Genehmigung des Herausgebers.

All rights reserved.
Reprinting and duplicating only with
permission of the publisher.



© Bender GmbH & Co. KG, Germany
Subject to change! The specified
standards take into account the edition
valid until 09.2023 unless otherwise
indicated.