

Product overview

ISOMETER® – Insulation monitoring devices

ISOSCAN® – Insulation fault location systems EDS

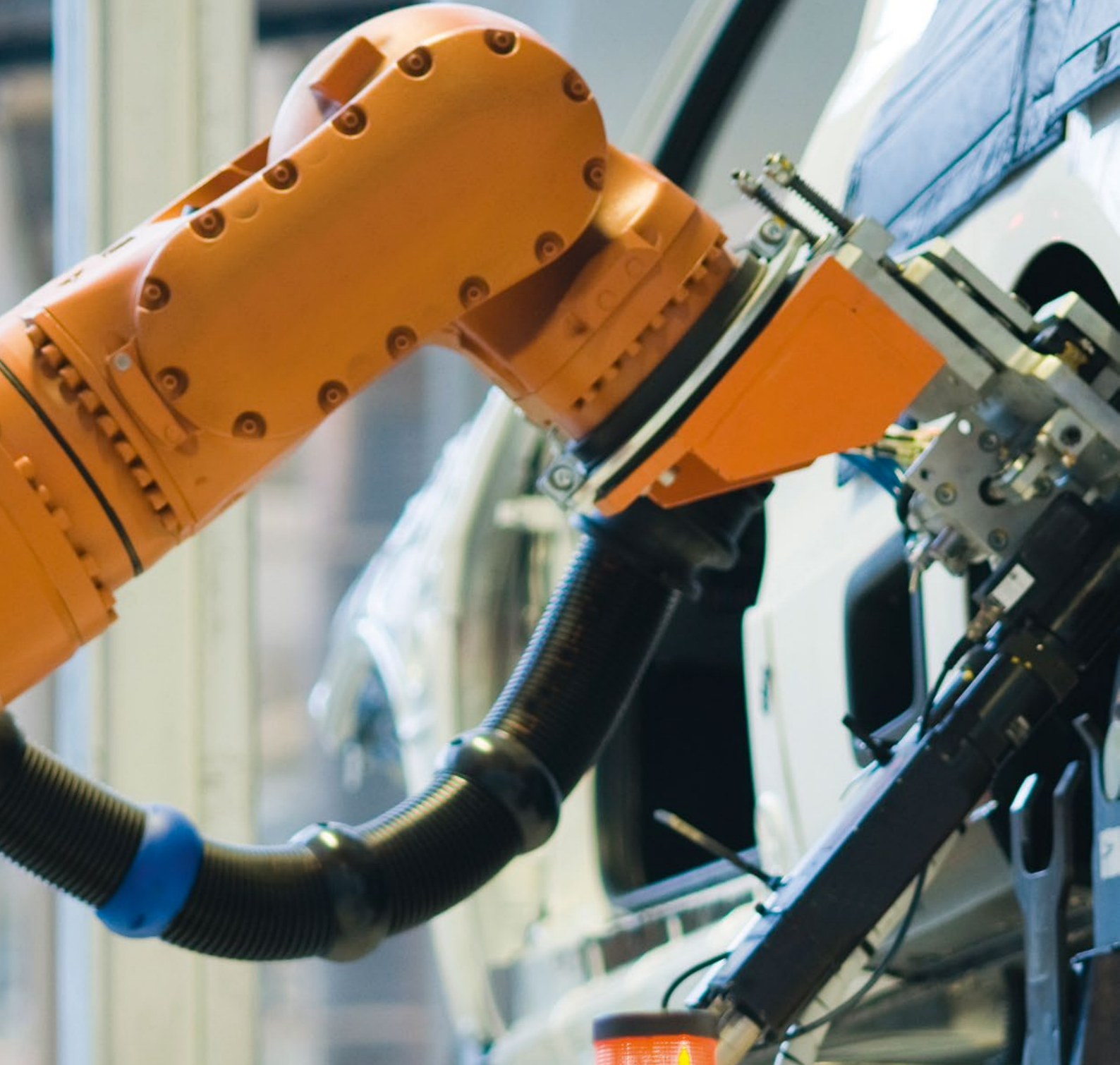



Find out today what will not happen tomorrow

Reporting critical operating states today, so that unwanted incidents such as operational interruptions, costly material damage or even physical injuries do not happen.

Safety of power supply

To ensure electrical safety for people and electrical installations in an efficient way on a long-term basis, Bender offers insulation monitoring devices for all the key industries. In particular, these devices are used anywhere where a safe power supply is an essential requirement to prevent system failures, eliminate the risk of serious or fatal injuries and to avoid material damage.

Top-level productivity and maximum safety for people and the electrical installation

With Bender insulation monitoring devices for unearthed power supplies (IT systems) you are already using the technology of tomorrow with respect to reliability, measurement

methods and design. Along with precise measurement technology, the ISOMETERS® provide many functions for early detection and quality assurance with user-friendly and intuitive operation, reliable evaluation and simple communication.

Fast localisation of insulation faults

Bender insulation fault location systems enable fast localisation and elimination of insulation faults even during operation. Disconnection of the electrical installation is not required. Portable Bender solutions facilitate the use in large installations with sub-distributions.

For more than 70 years, Bender has been a name for advanced technology using the latest „Made in Germany“ measurement technology and outstanding technical expertise. Because of this, Bender offers an exceptionally long warranty period of five years.

Contents

■ Unearthed power supply systems	4	■ Insulation fault location systems EDS	26
■ IT systems – information ahead of time	5	– Insulation monitoring devices with	
■ Insulation monitoring devices ISOMETER®		locating current injector	27
– High system availability in main circuits	6	– Insulation fault locators ISOSCAN®	28
– Control and auxiliary circuits	10	– Insulation fault locators with	
– Main circuits	12	integrated transformer	31
– Specific applications	14	– Portable equipment for insulation fault location	32
■ Accessories		■ Communication solutions	34
– Coupling devices	22	■ Retrofit	36
– Measuring instruments	23	■ POWERSCOUT®	37
– Gateways	24	■ Support during all phases	38

For a high level of operational and electrical system safety: Unearthed power supply systems (IT systems)

Modern power supplies require maximum availability, safety and predictive information

Given a wide variety of production processes, continuous competitive pressure, the impact of soaring costs and operational availability around the clock, the maximum possible electrical safety for power supplies is required. Although great care has been taken during the design and implementation phases and is continued throughout the maintenance cycle, electrical installations may nevertheless be impaired by factors such as humidity, ageing, dirt, mechanical damage, to mention but a few. Undetected insulation faults can be disastrous and costly, especially when factors such as production failure, repairs, device replacement or even unplanned service work are counted.

Increasing availability - reducing costs

The key objective of any system operator must be to recognise faults at an early stage and eliminate the cause in an efficient way. To achieve this objective, a possible solution uses unearthed power supplies (IT systems) with insulation monitoring.

In IT systems, none of the active conductors is directly connected to earth. Therefore, on the occurrence of an insulation fault, only a small leakage current, essentially caused by system leakage capacitances, can flow.

The upstream fuse does not trip, hence continuous power supply and operation is ensured. Prompt information about possible hazards is given by the ISOMETER® which continuously monitors the insulation resistance between the system and earth.

ISOMETER®: A wide variety of solutions for all types of IT systems

For the whole range of electrical power supplies, Bender provides appropriate solutions for most applications. Taking all types of system structures and loads into account, ISOMETER®s using Bender's patented measuring principles guarantee reliable evaluation of the insulation resistance for:

- Nominal system voltages AC, DC or AC/DC up to 12 kV
- System configurations 1Ph, 3Ph, disconnected loads
- System leakage capacitances up to 2000 μF
- Response values from 0.2 k Ω to 10 M Ω

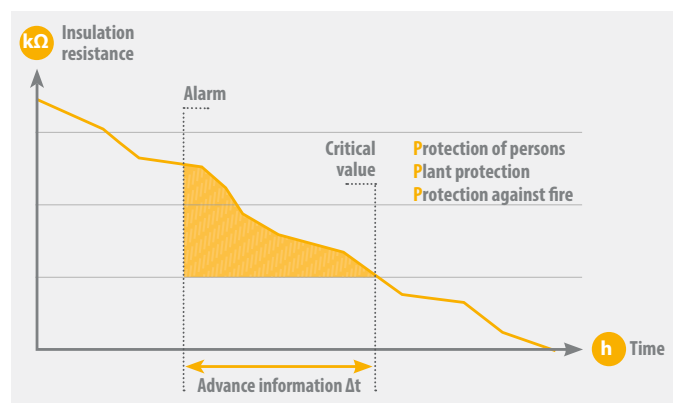

Information advantage through the ISOMETER®

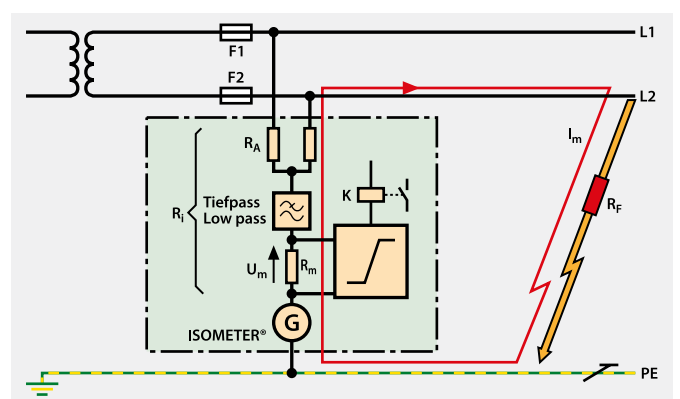

Principle of operation ISOMETER®

IT systems - information ahead of time

ISOMETER®s in IT systems are an effective means of damage prevention, they enable increased productivity and optimised maintenance, which in turn lead to considerable reduction in costs. Bender's wide range of products allows the implementation of individual safety solutions and safeguards your investment.



Optimised maintenance

- Recognise and signal insulation deteriorations early
- Localising faulty circuits automatically
- Optimising the planning of time and personnel resources
- Displaying information about the status of the electrical installation at a central location
- Remote diagnosis via Internet/Ethernet



Increased protection against fire

- Recognising developing insulation faults at an early stage
- Minimising arcing faults, a frequent cause of fire
- Separating areas prone to explosions and fire from the rest of the system by means of isolating transformers and monitoring them separately



Improved economic efficiency

- Avoiding expensive and unscheduled stoppages
- Reducing personnel expenses and time and costs for maintenance
- Detecting weak points in the installation
- Supporting business decisions on investments



High operational availability

- No interruption to operation in the event of a phase-to-earth fault
- No control malfunction in the event of insulation faults
- Electrical installations are kept at a high level of availability
- Monitoring electrical installations also during standstill

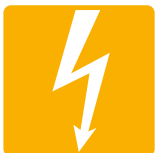

Enhanced accident prevention

- Low touch currents in small and medium-sized installations
- No malfunctions in case of earth faults in the control circuits of equipment and machines



Higher permissible earthing resistance

- Higher earthing resistances, permissible, for example, for mobile power supplies

High system availability in main circuits



Special applications					Quick response to combined resistance and offset voltage measurement	De-energised loads/ frequency converters
Circuits	Control circuits	■	■	■	■	■
	Main circuits	■	■	■	■	■
Voltage system	3(N)AC	■	■	■	■	■
	AC	■	■	■	■	■
	AC/DC	■	■	■	■	■
	DC	■	■	■		■
Nominal system voltage U_n		AC, 3(N)AC 0...690 V, DC 0...1000 V	AC, 3(N)AC 0...690 V, DC 0...1000 V	AC, 3(N)AC 0...690 V, DC 0...1000 V	AC, 3(N)AC 0...690 V (60 Hz)	offline
Tolerance of U_n		+ 15 %	+ 15 %	+ 15 %	+ 15 %	
System leakage capacitance C_e		≤ 1000 μF	≤ 1000 μF	≤ 1000 μF	≤ 150 μF	≤ 150 μF
Response value R_{an}		1 kΩ...10 MΩ	1 kΩ...10 MΩ	1 kΩ...10 MΩ	1 kΩ...10 MΩ	1 kΩ...10 MΩ
Coupled systems			■	■		
Locating current injector for insulation fault location				■		
Installation	DIN rail	■	■	■	■	■
	Screw mounting	■	■	■	■	■
	Panel mounting/ wall fastening	■	■	■		
Interfaces	Web server	■	■	■	■	■
	Modbus	TCP	TCP	TCP	TCP	TCP
	BCOM	■	■	■	■	■
	BS	■	■	■	■	■

Ordering information

Supply voltage U_s	Nominal system voltage U_n	Panel mounting	Option W ¹⁾	Type	Art. No.
AC 24...240 V; 50...400 Hz/ DC 24...240 V	AC, 3(N)AC 0...690 V; 1...460 Hz/ DC 0...1000 V	-	-	iso685-D	B91067010
			-40...+70°C, 3K5, 3M7	iso685W-D ¹⁾	B91067010W
		■	-	iso685-S + FP200	B91067210
			-40...+70°C, 3K5, 3M7	iso685W-S + FP200W ¹⁾	B91067210W
		-	-	iso685-D-B	B91067020
			-40...+70°C, 3K5, 3M7	iso685W-D-B ¹⁾	B91067020W
		■	-	iso685-S-B + FP200	B91067220
			-40...+70°C, 3K5, 3M7	iso685W-S-B + FP200W ¹⁾	B91067220W
		-	-	iso685-D-P	B91067030
			-40...+70°C, 3K5, 3M7	iso685W-D-P ¹⁾	B91067030W
		■	-	iso685-S-P + FP200	B91067230
			-40...+70°C, 3K5, 3M7	iso685W-S-P + FP200W ¹⁾	B91067230W
AC, 3(N)AC 0...690 V (60 Hz)	-	isoNAV685-D	B91067014		
offline	-	isoNAV685-D-B	B91067024		

¹⁾ Increased shock and vibration resistance 3K5 and 3M7.

Example applications

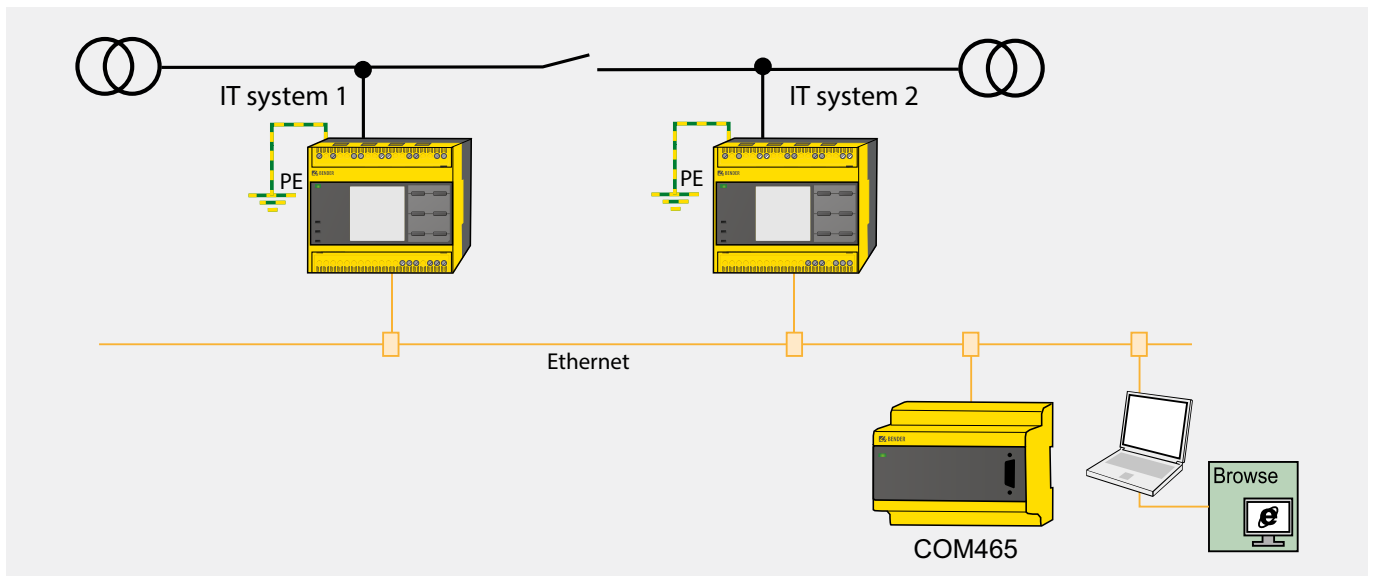

High system availability in main circuits



Special applications				Equipment for insulation fault location
Circuits	Control circuits			■
	Main circuits	■	■	■
Voltage system	3(N)AC	■	■	■
	AC	■	■	■
	AC/DC	■	■	■
	DC	■	■	■
Nominal system voltage U_n		AC, 3(N)AC 0...690 V DC 0...565 V	AC, 3(N)AC 0...690 V DC 0...565 V	dependent on type
Tolerance of U_n		+ 15 %	+ 15 %	+ 15 %
System leakage capacitance C_e		≤ 500 μF	≤ 500 μF	≤ 500 (150) μF
Response value R_{an}		1 kΩ...1 MΩ	1 kΩ...1 MΩ	1 kΩ...1 MΩ
Coupled systems		■	■	■
Locating current injector for insulation fault location				■
Installation	DIN rail	■		
	Screw mounting	■	■	
	Panel mounting/ wall fastening		■	■
Interfaces – BMS		■	■	■

Ordering information

applicable for coupled IT systems	Nominal system voltage U_n	Supply voltage U_s	Type	Art. No.
-	AC, 3(N)AC 0...690 V DC 0...565 V	AC 88...264 V/DC 77...286 V	IRDH275-435	B91065100
		DC 19,2...72 V	IRDH275-427	B91065104
		DC 10,2...36 V	IRDH275-425	B91065108
■	AC, 3(N)AC 0...690 V DC 0...565 V	AC 88...264 V/DC 77...286 V	IRDH275B-435	B91065101
		DC 19,2...72 V	IRDH275B-42	B91065105
		DC 10,2...36 V	IRDH275B-425	B91065109
-	AC, 3(N)AC 0...690 V DC 0...565 V	AC 88...264 V/DC 77...286 V	IRDH375-435	B91065000
		DC 19,2...72 V	IRDH375-427	B91065002
■	AC, 3(N)AC 0...690 V DC 0...565 V	AC 88...264 V/DC 77...286 V	IRDH375B-435	B91065004
		DC 19,2...72 V	IRDH375B-427	B91065006
■	AC, 3(N)AC 20...575 V DC 20...575 V	DC 19,2...72 V	IRDH575B1-427	B91065502
		AC 88...264 V/DC 77...286 V	IRDH575B1-435	B91065500
	AC, 3(N)AC 20...150 V DC 20...150 V	DC 19,2...72 V	IRDH575B1-4227 ¹⁾	B91065505
		AC 88...264 V/DC 77...286 V	IRDH575B1-4235	B91065504
	AC, 3(N)AC 340...760 V DC 340...575 V	DC 19,2...72 V	IRDH575B2-427	B91065506
		AC 88...264 V/DC 77...286 V	IRDH575B2-435	B91065503

Device "Option-W" with increased shock and vibration resistance: Indicated by the letter "W" at the end of the order number.

Example applications

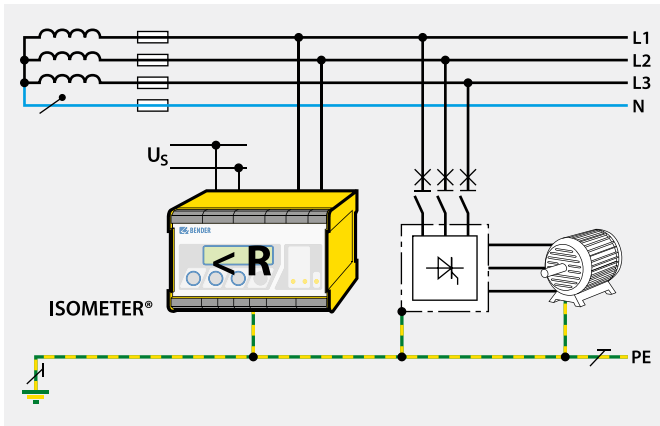

AC/DC main circuits with a variable-speed drive

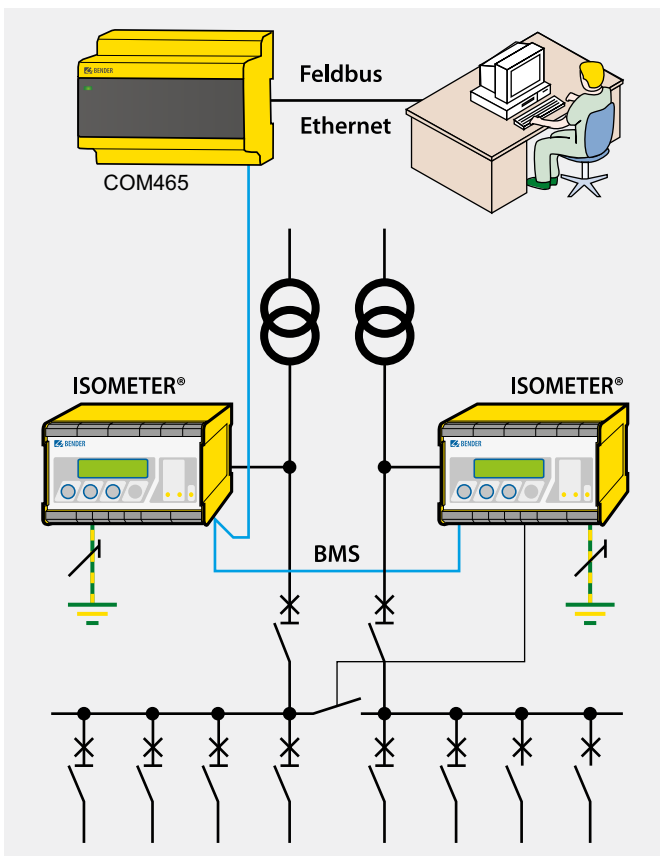

Coupled IT systems

Maximum operational safety in control and auxiliary circuits



Circuits	Control circuits	■	■	■
	Main circuits	-	-	-
Voltage system	3(N)AC	-	-	-
	AC	■	■	■
	AC/DC	-	■	■
	DC	-	■	■
Nominal system voltage U_n		AC 0...300 V	AC 19,2...265 V, DC 19,2...308 V	AC/DC 0...300 V
Frequency range f_n		AC 42...460 Hz	DC, 42...460 Hz	DC, AC 15...460 Hz
System leakage capacitance C_e μ F		≤ 20 μ F	≤ 10 μ F	≤ 20 μ F
Response value	Response value R_{an} k Ω	1...200 k Ω	10...200 k Ω	1...200 k Ω
	Alarm contacts	2 changeover contacts	1 changeover contact	2 changeover contacts
	Operating principle	N/O or N/C operation	N/C operation	N/O or N/C operation
	Response time t_{an} (at $R_f = 0.5 \times R_{an}$ and $C_e = 1$ μ F)	≤ 1 s	≤ 6 s	≤ 2 s
	Start-up delay t	0...10 s	-	0...10 s
	Response delay t_{on}	0...99 s	-	0...99 s
Indication	LC display	■	-	■
	Power On LED	■	■	■
	Alarm LEDs	■	■	■
Installation	DIN rail	■	■	■
	Screw mounting	■	■	■

Ordering information

Nominal voltage U_n	Supply voltage ¹⁾ U_s	Type	Art. No.
AC 0...300 V, 42...460 Hz	AC 16...72 V, 42...460 Hz/DC 9,6...94 V	IR420-D4-1	B71016409
	AC/DC 70...300 V/DC 42...460 Hz	IR420-D4-2	B71016405
DC 19,2...308 V/AC 19,2...365 V	= U_n	IR125Y-4	B91023005
AC/DC 0...300 V, 15...460 Hz	AC 16...72 V, 15...460 Hz/DC 9,6...94 V	IR425-D4-1	B71036403
	AC/DC 70...300 V/DC 15...460 Hz	IR425-D4-2	B71036402

Device version with screw terminals on request.

¹⁾ Absolute values

Accessories

Type designation	Art. No.
Mounting clip for screw mounting (1 piece per device)	B 9806 0008

In localised areas, such as machine control systems or safety lighting where space is limited, control and auxiliary circuits provide additional functions, such as command output, interlocking, messaging and measuring. For these circuits, particular emphasis is placed on operational reliability.

Example applications

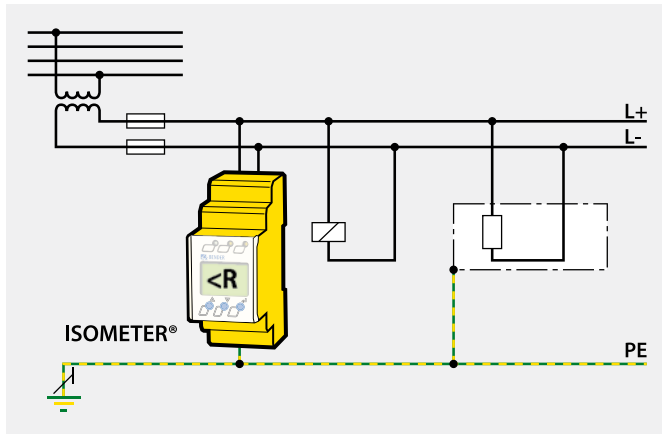

AC control circuit with IR420

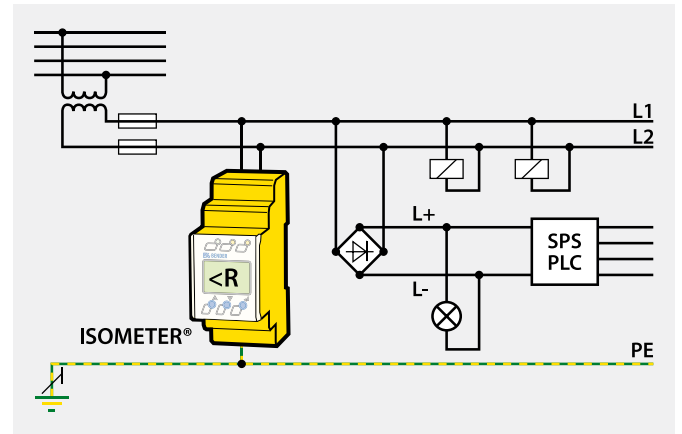

AC/DC control circuit with IR425

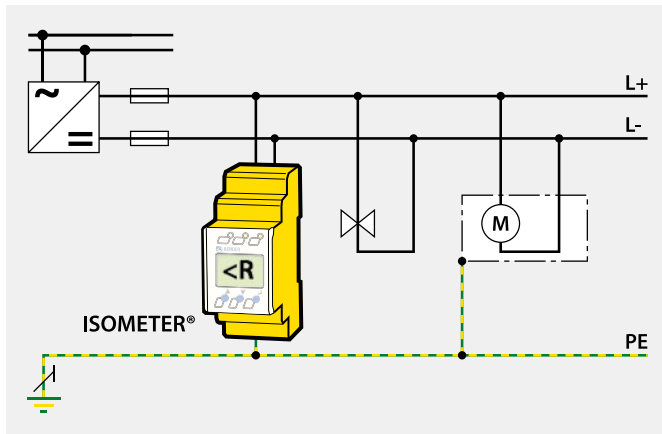

DC control circuit with IR425

High system availability in main circuits



Circuits	Control circuits	–	–	■	■
	Main circuits	■	■	■	■
Voltage system	3(N)AC	■	■	■	■
	AC	■	■	■	■
	AC/DC	–	–	■	■
	DC	–	–	■	■
Nominal system voltage U_n		AC, 3(N)AC 0...793 V ¹⁾	AC, 3(N)AC 0...793 V ¹⁾	AC 0...1000 V / DC 0...1500 V	AC 0...1000 V / DC 0...1500 V
Frequency range f_n		AC 40...460 Hz	AC 40...460 Hz	DC 0,1...460 Hz	DC 0,1...460 Hz
System leakage capacitance C_e μ F		≤ 20 μ F	≤ 20 μ F	≤ 500 μ F	≤ 2000 μ F
Nominal voltage range U_n expandable (via coupling devices)		AGH204S-4/AGH520S	AGH204S-4/AGH520S	–	–
Response value R_{an} k Ω		1...200 k Ω	10...100 k Ω 35...500 k Ω	200 Ω ...1 M Ω	200 Ω ...1 M Ω
Communication	LC display	–	–	–	■
	Power On LED	■	■	■	■
	Alarm LEDs	■	■	■	■
	RS-485 interface	–	–	■	■
Installation	DIN rail	■	■	–	–
	Screw mounting	■	■	■	■
	Panel mounting/wall fastening	–	–	–	–

Ordering information

Nominal voltage U_n	Supply voltage U_s	Type	Art. No.
AC 0...793 V ¹⁾	AC 230 V	IR470LY-40	B 9104 8007
	AC 24 V	IR470LY-4011	B 9104 8012
	AC 42 V	IR470LY-4012	B 9104 8002
	AC 90...132 V ¹⁾	IR470LY-4013	B 9104 8011
	AC 400 V	IR470LY-4015	B 9104 8008
	AC 500 V	IR470LY-4016	B 9104 8018
	AC 690 V	IR470LY-4017	B 9104 8017
	AC 440 V	IR470LY-4018	B 9104 8024
	DC 9,6...84 V ¹⁾	IR470LY-4021	B 9104 8006
	DC 77...286 V ¹⁾	IR470LY-4023	B 9104 8026
AC 0...1000 V / DC 0...1500 V	DC 18...30V	IR470LY2-4061	B 9104 8052
		iso1685DP-425	B91065802
		iso1685P-425	B91065801

¹⁾ Absolute values

Main circuits provide the power supply for electrical installations or buildings. These circuits include equipment for generating, converting, distributing, switching and consuming electrical energy. From the user's point of view, different types of loads should be distinguished between: pure AC loads (e.g. motors), AC/DC loads containing electronic components (e.g. converters) and pure DC loads (e.g. battery systems).

Example applications

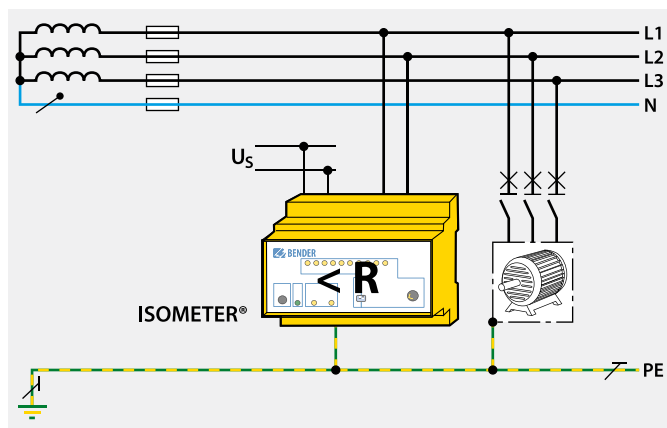

AC main circuits with one motor

Recognising faults at an early stage in specific applications



Circuits	Control circuits	–	–	–	–	–	–	–
	Main circuits	■	■	■	■	■	■	■
Voltage system	3(N)AC	■	–	■	■	–	–	–
	AC	■	■	■	■	■	–	–
	AC/DC	■	–	–	■	■	–	–
	DC	■	–	–	■	■	■	■
Nominal system voltage U_n	AC, 3(N)AC/DC 0...15,5 kV	AC 70...264 V ¹⁾	AC 230 V AC 127 V	via AGH-PV 3(N)AC 0...793 V DC 0...1100 V ¹⁾	DC 0...1100 V, AC 0...793 V ¹⁾	DC 0...1500 V	DC 0...1500 V	
Frequency range f_n	DC, AC 0,2...460 Hz	AC 47...63 Hz	AC 50...60 Hz	via AGH-PV DC, 10...460 Hz	via AGH420 DC, 10...460 Hz	DC	DC	
System leakage capacitance C_e	≤ 5 μF	≤ 5 μF	≤ 5 μF	≤ 2000 μF	≤ 500 μF	≤ 2000 μF	≤ 2000 μF	
Response value R_{an} kΩ	100 kΩ...10 MΩ	50...500 kΩ	50...500 kΩ	0,2...100 kΩ	1...490 kΩ	200 Ω...1 MΩ	200 Ω...1 MΩ	
Indication	LC display	■	■	■	■	–	–	
	Power On LED	■	■	–	–	■	■	
	Alarm LEDs	■	■	■	■	■	■	
	RS-485 interface BMS	■	■	■	■	■	■	
	RS-485 interface MODBUS	–	–	–	–	–	■	
	CAN	–	–	–	–	–	■	
Installation	DIN rail	■	■	■	■	–	–	
	Screw mounting	■	■	■	■	■	■	

Ordering information

Nominal system voltage U_n	Supply voltage ¹⁾ U_s	Type	Art. No.
–	AC 19.2...72 V	IRDH275BM-7	B 9106 5120
AC 70...264 V, 42...460 Hz	AC 70...264 V, 42...460 Hz	IR427-2	B 7207 5300 ²⁾
AC 230 V, 50...60 Hz	AC 230 V, 50...60 Hz	107TD47	B 9201 6003
AC 127 V, 50...60 Hz	AC 127 V, 50...60 Hz	107TD47-133	B 9201 6004
AC 0...793 V, DC 0...1100 V	DC 19.2...72 V	isoPV-327 + AGH-PV consisting of: isoPV-327 (B 9106 5130W), AGH-PV (B 9803 9020W)	B 9106 5132W
AC 0...793 V, DC 0...1100 V	AC 88...264 V, DC 77...286 V	isoPV-335 + AGH-PV consisting of: isoPV-335 (B 9106 5131W), AGH-PV (B 9803 9020W)	B 9106 5133W
AC 0...690 V, DC 0...1000 V	AC 100...240 V, 47...63 Hz/DC 24...240 V	isoPV425-D4-2 with AGH420	B 7103 6303 ²⁾
DC 0...1500 V	DC 18...30 V	isoPV1685RTU-425	B91065603
		isoPV1685P-425	B91065604
		isoPV1685PFR-425	B91065600

¹⁾ Absolute values

²⁾ Device version with screw terminals on request.

Our product range includes a variety of products, such as ISOMETER®s for low-resistance DC systems, systems containing AC/DC medium-voltage converters up to 12 kV, mobile generators or disconnected loads. Should you have any questions, please do not hesitate to contact our Technical Sales Department.

Standard-compliant solutions for

- Medical locations
- Photovoltaic
- Installations with a low level of insulation
- Disconnected loads
- Mobile generators
- Electric mobility
- Railway, rolling stock

Example applications

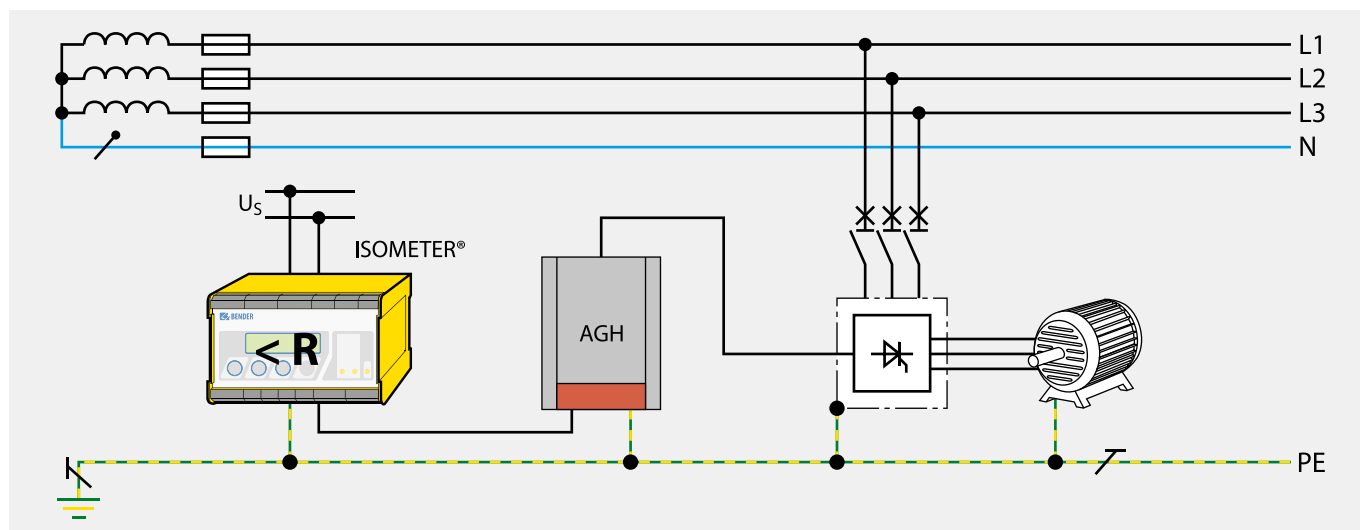

Monitoring of medium-voltage drives with IRDH275... and coupling device AGH675S-7

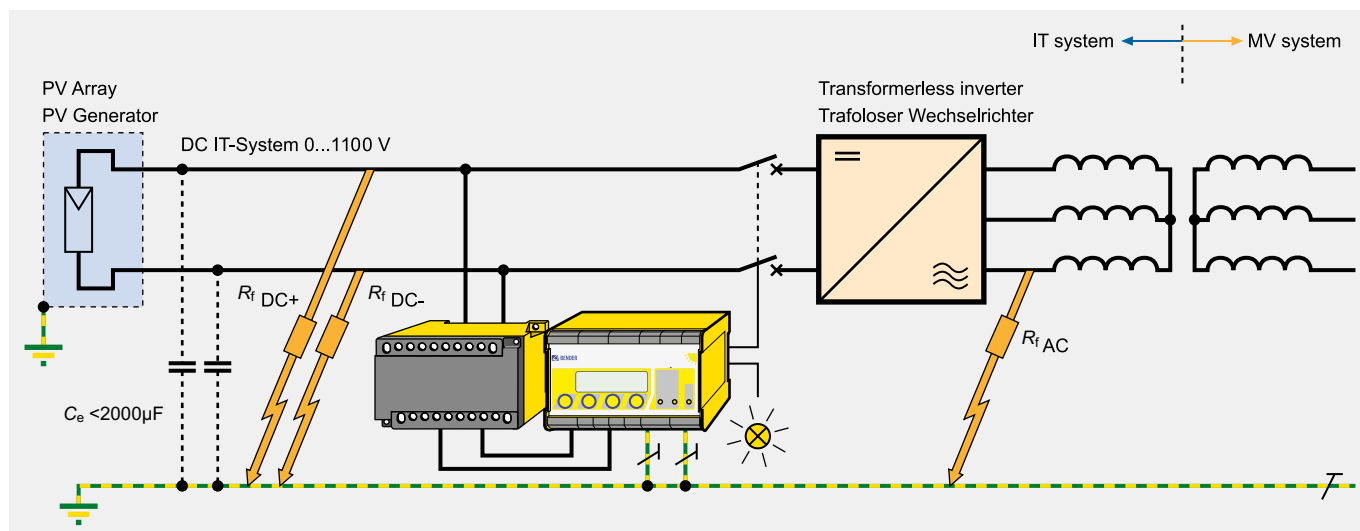

PV generator unearthed (IT system) with nominal voltage $\leq 1100\text{ V}$ and ISOMETER® isoPV with coupling device AGH-PV

Ordering information

Nominal system voltage U_n	Supply voltage U_s ¹⁾	Type	Art. No.
AC 0...793 V, DC 0...1100 V	DC 19.2...72 V	isoLR275-327 + AGH-LR-3 consisting of: isoLR275-327 (B 9106 5700W), AGH-LR-3 (B 9803 9022W)	B 9106 5702W
	AC 88...264 V, DC 77...286 V	isoLR275-335 + AGH-LR-3 consisting of: isoLR275-335 (B 9106 5701W), AGH-LR-3 (B 9803 9022W)	B 9106 5703W
AC 0...793 V	AC 230 V	IR470LY2-60	B 9104 8010
	AC 90...132 V ¹⁾	IR470LY2-6013	B 9104 8013
	AC 400 V	IR470LY2-6015	B 9104 8009
	DC 9.6...84 V ¹⁾	IR470LY2-6021	B 9104 8014
-	AC 16...72 V, 42...460 Hz/DC 9.6...94 V	IR420-D6-1	B 7101 6415
	AC 70...300 V, 42...460 Hz/DC 70...300 V	IR420-D6-2	B 7101 6407
		IR420-D64-2	B 7101 6408
AC 0...300 V	AC 16...72 V, 30...460 Hz/DC 9.6...94 V	IR423-D4-1	B 7101 6304
	AC/DC 70...300 V, 30...460 Hz	IR423-D4-2	B 7101 6305
	AC 16...72 V, 30...460 Hz/DC 9.6...94 V	IR423-D4W-1	B 7101 6304W
	AC/DC 70...300 V, 30...460 Hz	IR423-D4W-2	B 7101 6305W
AC 100...300 V, 22...460 Hz	$U_s = U_n$	IR123P-4-2	B 9101 6308

¹⁾ Absolute values

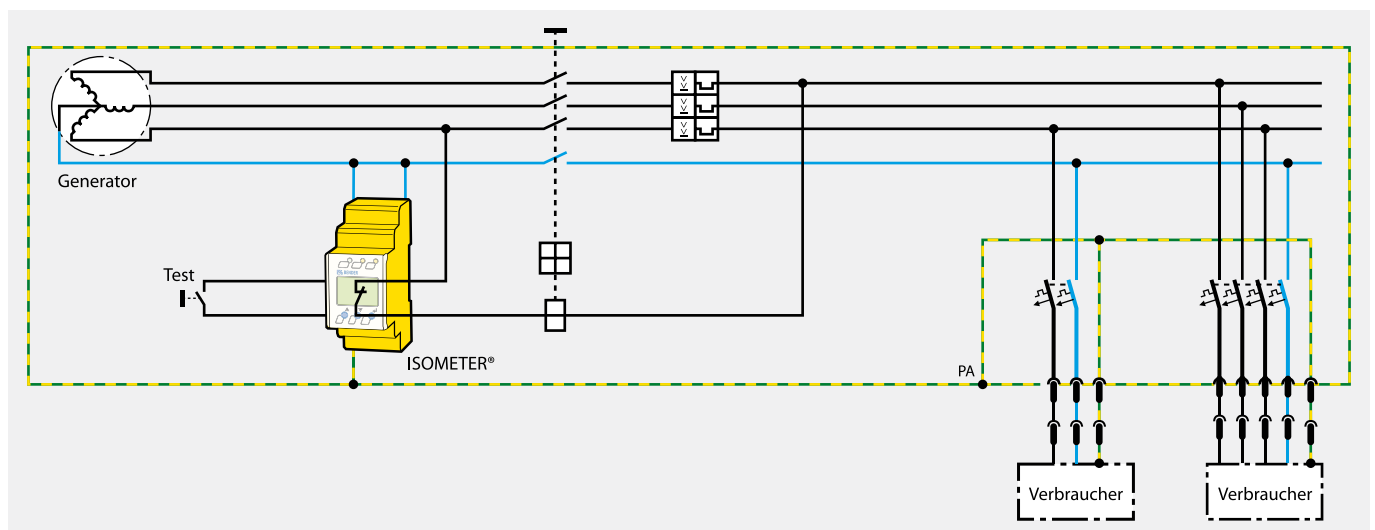

Monitoring of mobile generators with IR423

Specific applications



Circuits	Control circuits	–	–	–
	Main circuits	■	■	■
Voltage system	3(N)AC	–	–	–
	AC	–	–	–
	AC/DC	–	–	–
	DC	■	■	■
Nominal system voltage U_n		DC 0...1000 V	DC 0...1000 V AC 0...690 V, 15...460 Hz	DC 0...600 V
Frequency range f_n		+ 0 %	+ 10 % + 15 %	+ 15 %
System leakage capacitance C_e		$\leq 1 \mu\text{F}$	$\leq 5 \mu\text{F}$	$\leq 1 \mu\text{F}$
Response value R_{an}		100...10000 k Ω	10...990 k Ω	30 k Ω ...1 M Ω ; 40 k Ω ...2 M Ω
Installation	DIN rail	–	■	–
	Screw mounting	■	■	■
Interface	Modbus	–	RTU	–
	BMS	–	■	–

Ordering information

Nominal system voltage U_n	Supply voltage ¹⁾ U_s	Type	Art. No.
AC 0...1000 V, DC 0...1000 V	DC 10...36 V	IR155-3203	B 9106 8138V4
		IR155-3204	B 9106 8139V4
		IR155-3203	B 9106 8138CV4 ²⁾
		IR155-3204	B 9106 8139CV4 ²⁾
AC 0...793 V, 15...460 Hz/DC 0...1100 V	AC 100...240 V, 47...63 Hz/DC 24...240 V	isoEV425-D4 with AGH420	B 7103 6401 ²⁾
DC 0...600 V	DC 12 V	iso165C	B91068175

¹⁾ Device version with screw terminal on request.

²⁾ Custom setting possible

Example applications

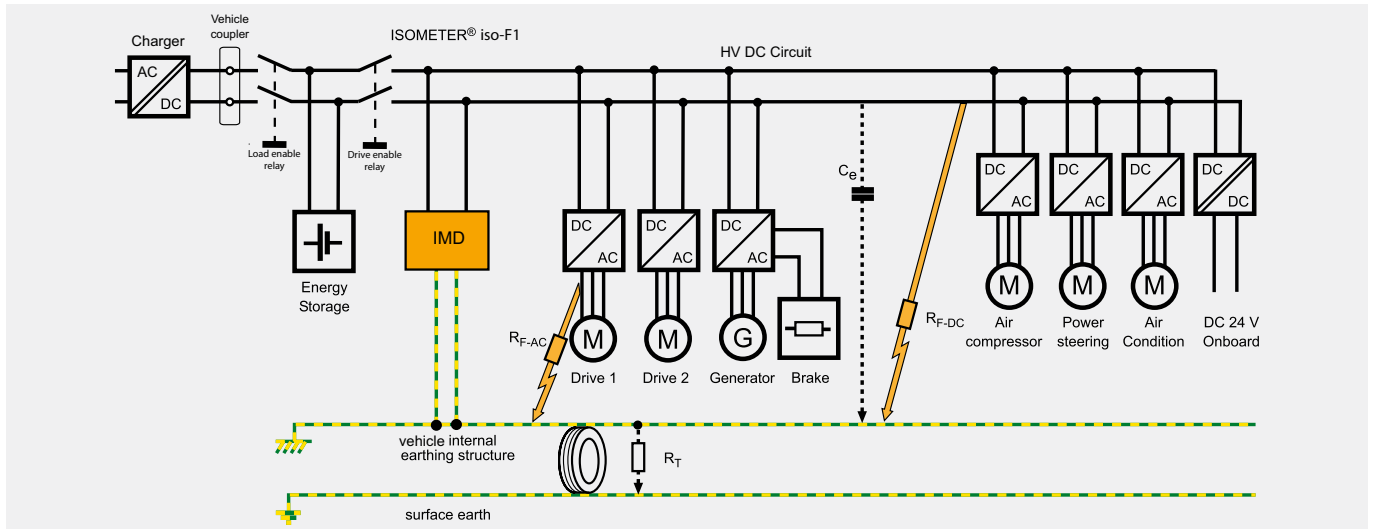

Monitoring of unearthed DC drive systems in electric vehicles with IR155

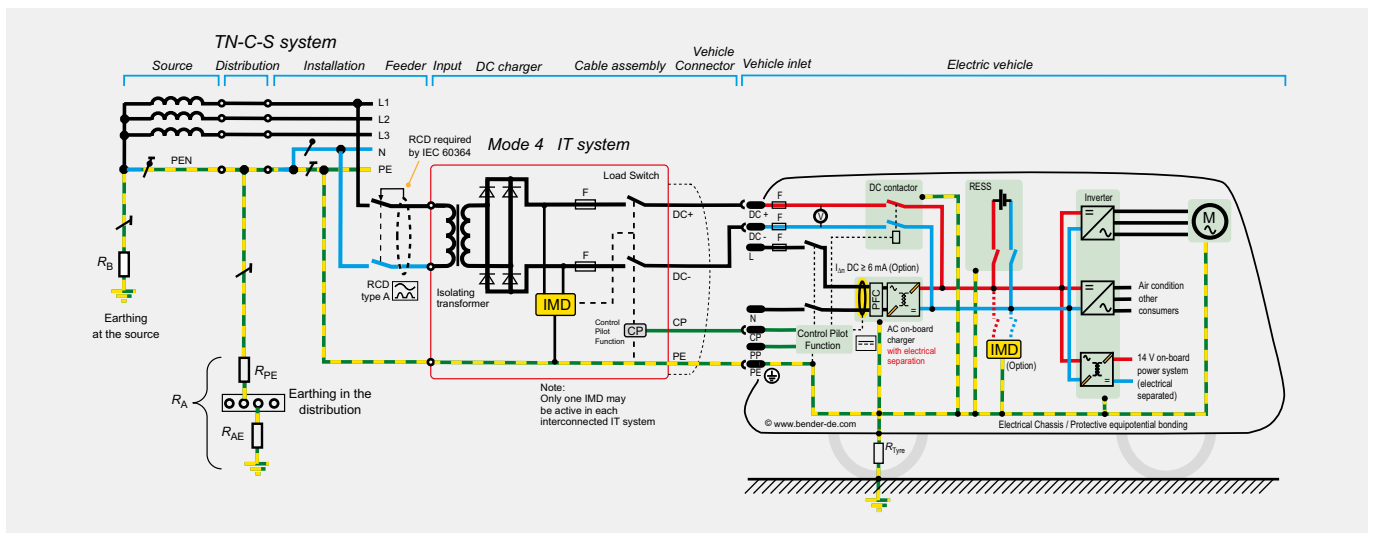

Monitoring of unearthed DC circuits for charging electric vehicles with isoEV425

Specific applications



		Control circuits	Main circuits
Voltage system	Control circuits	–	■
	Main circuits	■	■
	3(N)AC	■	■
	AC	■	■
Voltage system	AC/DC	■	■
	DC	■	■
Nominal system voltage U_n		AC/DC 0...400 V	AC, 3(N)AC 0...690 V, DC 0...1000 V
Frequency range f_n		+25 %	+15 %
System leakage capacitance C_e		≤ 300	≤ 1000
Response value R_{an}		1...990	1...10000
Installation	DIN rail	■	■
	Screw mounting	■	■
Interface	Web server	–	■
	Modbus	RTU	TCP
	BCOM	–	■
	BS	–	■
	BMS	■	–

Ordering information

Nominal system voltage U_n	Supply voltage ¹⁾ U_S	System leakage capacitance C_e	Type	Art. No.
3(N)AC, AC/DC 0...400 V	AC 100...240 V/DC 24...240 V	< 300 µF	isoRW425-D4W-4	B71037000W ²⁾
AC 0...690 V, 1...460 Hz/DC 0...1000 V	AC 24...240 V, 50...400 Hz/DC 24...240 V	≤ 1000	isoRW685W-D	B91067012W

¹⁾ Absolute values

²⁾ Device version with screw terminal on request.

Application example

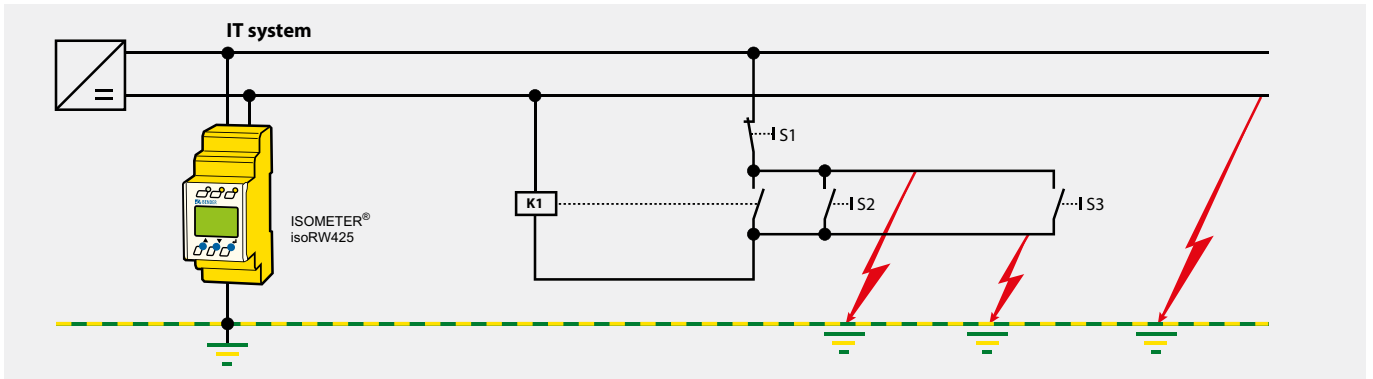

Monitoring of the complete IT system $\leq 400\text{ V}$ with isoRW425

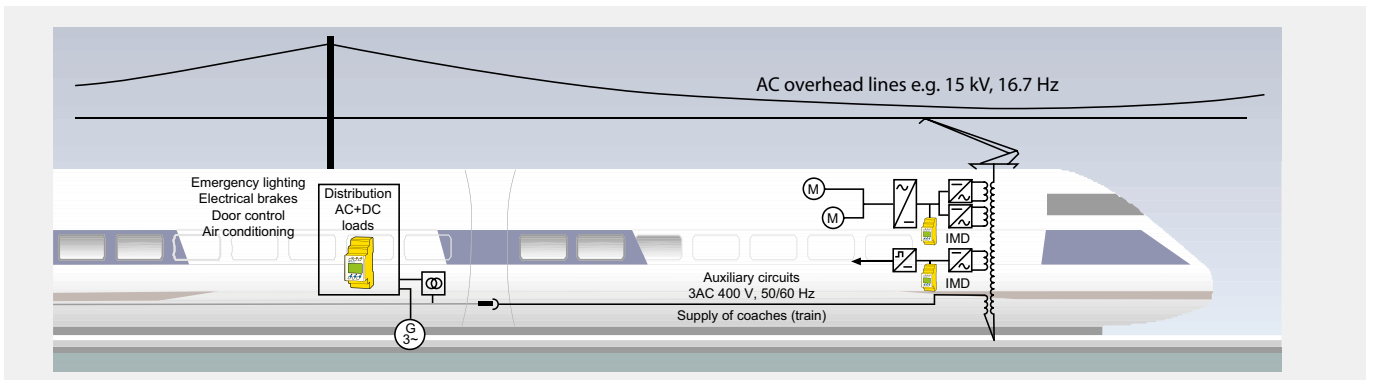

Universal use of the isoRW425 for IT systems $\leq 400\text{ V}$

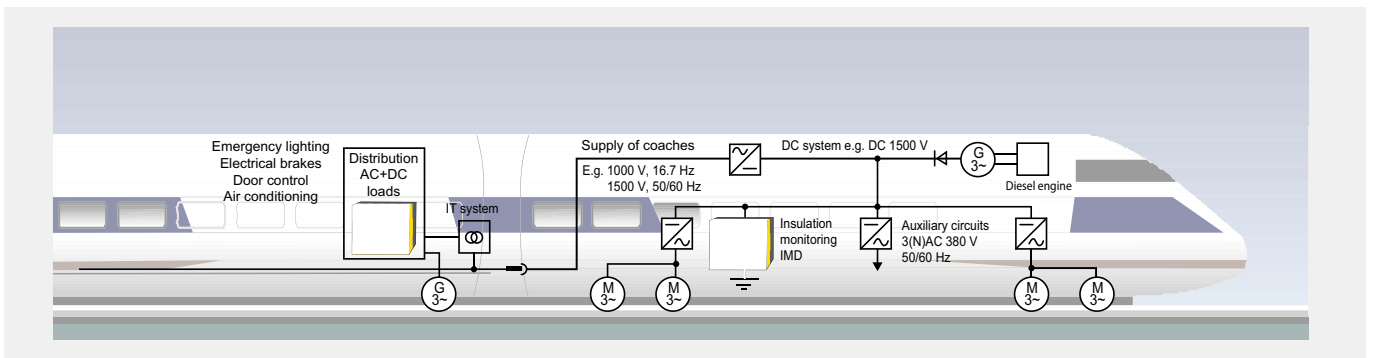

Universal use of the isoRW685 for IT systems $> 400\text{ V}$

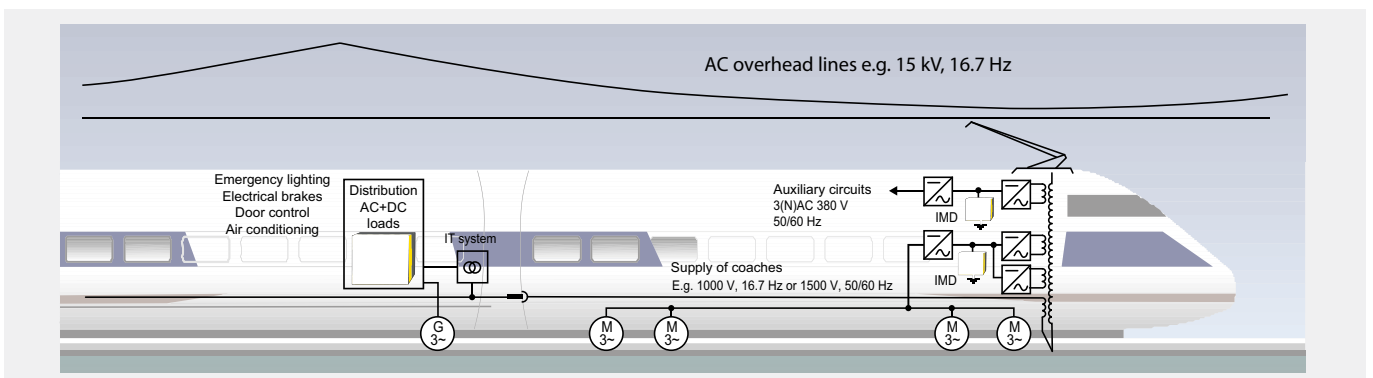

Universal use of the isoRW685 for IT systems $> 400\text{ V}$

Accessories

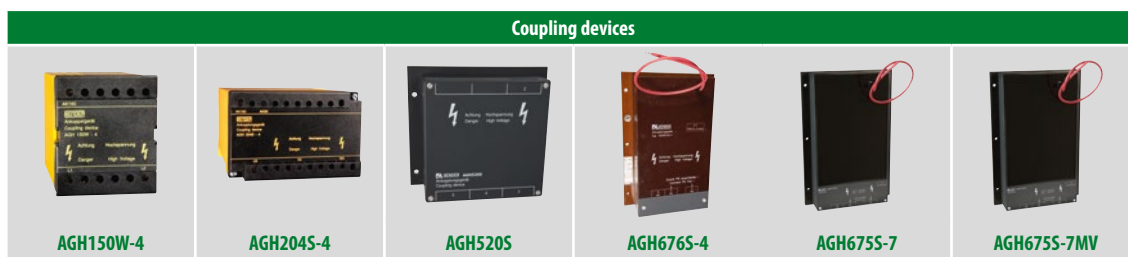

Application		Extension of the nominal voltage range for ISOMETER®s					
Nominal system voltage U_n		AC 0...1150 V, DC 0...1760 V	AC 0...1300 V/ AC 0...1650 V	AC/3(N)AC 0...7200 V	AC/3(N)AC 0...1200 V	AC, 3(N)AC, DC 0...7200 V	AC, 3(N)AC, DC 0...15500 V
Device family	IR470LY...	-	■	■	-	-	-
	IRDH275/375	■	■	■	■	-	-
	IRDH275BM	-	-	-	-	■	■
	IR420-D64	-	-	-	■	-	-
	iso685-D	■	■	■	■	-	-
	iso685-S	■	■	■	■	-	-

Ordering information

Nominal system voltage U_s	Type	Art. No.
AC 0...1150 V/DC 0...1760 V	AGH150W-4	B98018006
AC 0...1650 V/0...1300 V	AGH204S-4	B914013
3(N)AC 0...7200 V	AGH520S	B913033
AC, 3(N)AC, DC 0...7.2 kV, 0...460 Hz	AGH675S-7-500	B913056
	AGH675S-7-2000	B913054
AC, 3(N)AC, DC 0...15.5 kV, 0...460 Hz	AGH675S-7MV15-500	B913058
AC/3(N)AC 0...12 kV, 50...460 Hz	AGH676S-4	B913055

Measuring instruments

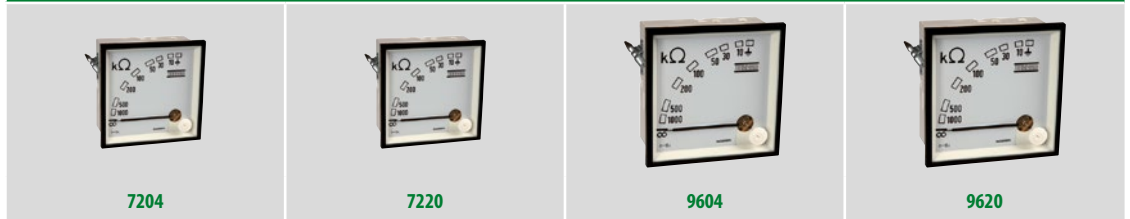

Input current		0...400 μ A	0...20 mA	0...400 μ A	0...20 mA
Dimensions (mm)		72 x 72	72 x 72	96 x 96	96 x 96
Device family	IR470LY...	■	–	■	–
	IR470LY2-6...	–	–	■	–
	IRDH275/375	■	–	■	–
	IRDH275B/375B	–	■	■	■
	IRDH575	–	■	■	■
	iso685...	■	■	■	■

Ordering information

Scale	Input current	Dimensions	Midscale (SKMP)	Type	Art. No.
Division	0...400 μ A	72 x 72 mm	120 k Ω	7204-1421	B 986 763
				7204S-1421	B 986 804
		96 x 96 mm	120 k Ω	9604-1421	B 986 764
				9604S-1421	B 986 784
	0...20 mA	96 x 96 mm	120 k Ω	9620-1421	B 986 841
				9620S-1421	B 986 842
	0...400 μ A	96 x 96 mm	1.2 M Ω	9604-1621	B 986 782
				7220-1421	B 986 844
	0...20 mA	72 x 72 mm	120 k Ω	7220S-1421	B 986 848

Accessories



Application		BMS-Modbus RTU-Gateway	Condition Monitor/Gateway	Condition Monitor/ PROFIBUS-Gateway	Condition Monitor/Gateway
Functions	Protocol input	BMS	BMS/Modbus RTU/TCP	BMS/Modbus RTU/TCP	BMS/Modbus RTU/TCP
	Protocol output	Modbus RTU	Ethernet/Modbus TCP	Ethernet/Modbus TCP, PROFIBUS DP	Ethernet/Modbus TCP
	Indication	LCD/LED	LED	LED	7"-Farb-LCD
	Alarm messages	■	■ 1,2)	■ 1,2)	■ 1,2,3)
	Measured values	■	■ 1,2)	■ 1,2)	■ 1,2,3)
	Device parameter setting		■ 1)	■ 1)	■ 1)
	Alarm list		■ 1)	■ 1)	■ 1,3)
	History memory		■ 1)	■ 1)	■ 1)
	Diagrams		■ 1)	■ 1)	■ 1,3)
	Visualisation		■ 1)	■ 1)	■ 1)
	E-mail notification		■ 1,4)	■ 1,4)	■ 1,4)
	Device tests	■	■ 1,2)	■ 1,2)	■ 1,2)
	PEM... and energy meter support		■ 1)	■ 1)	■ 1)
	SNMP		■ 1)	■ 1)	■ 1)
Data logger		■ 1)	■ 1)	■ 1)	
Connection	BMS	Schraubklemme	Schraubsteckklemme	Schraubsteckklemme	Schraubsteckklemme
	Output	Schraubklemme	RJ 45	RJ 45, Sub-D 9-polig	RJ 45
System requirements	Supply voltage U_s	AC/DC 76...276 V	AC/DC 24...240 V, DC 24V	AC/DC 24...240 V, DC 24V	DC 24 V
	Browser		Internet Explorer, Chrome, Firefox etc.	Internet Explorer, Chrome, Firefox etc.	Internet Explorer, Chrome, Firefox etc.

- 1) Available functions on the web server – Accessible by means of a PC using a browser
- 2) Available via protocol
- 3) On the device's own LC display
- 4) TLS/SSL support

Ordering information

Supply voltage/frequency range U_s	Supply voltage/frequency range U_s for UL applications	Power consumption	Type	Art. No.
AC/DC 76...276 V, 42...460 Hz	AC 76...250 V, 40...150 mA, 42...460 Hz/ DC 76...250 V, 10...35 mA	3.5...40 VA, 2.4 W	COM462RTU	B95061022
AC/DC 24...240 V, 50...60 Hz	–	≤ 6.5 VA, ≤ 4 W	COM465IP-230V	B95061065
DC 24	–	≤ 3 W	COM465IP-24V	B95061066
AC/DC 24...240 V, 50...60 Hz	–	≤ 6.5 VA, ≤ 4 W	COM465DP-230V	B95061060
DC 24	–	≤ 3 W	COM465DP-24V	B95061061
DC 24 V/ ± 25 %	–	typ. 11 W, max. 26 W	CP700	B95061030

Function modules for COM465IP, COM465DP and CP700

Anwendung	Funktionsmodul (Software-Lizenz)	Art.-Nr.
Individual text messages for all devices/channels, device failure monitoring, e-mail in the event of an alarm	Function module A	B75061011
Modbus TCP server for max. 98 * 139 BMS nodes as well as BCOM and universal measuring devices, SNMP server	Function module B	B75061012
Parameter setting of BMS devices as well as BCOM and universal measuring devices	Function module C	B75061013
Visualisation of Bender systems, System visualisation	Function module D	B75061014
Virtual devices	Function module E	B75061015
Integration of third-party devices	Function module F	B75061016

Insulation monitoring devices ISOMETER® with locating current injectors



Application		Insulation fault location system			
Circuits	Control circuits	■		■	
	Auxiliary circuits	■			
	Main circuits	■	■	■	
Nominal system voltage U_n		AC, 3(N)AC 0...690 V, DC 0...1000 V	U_n (B1) 3AC/AC 20...575 V DC 20...575 V (B1-Version) U_n (B2) 3AC/AC 340...760 V DC 340...575 V (B2-Version)	U_n (B1) 3AC/AC 20...150 V/DC 20...150 V (Version IRDH575B1-4227, IRDH575B1-4235) U_n (B2) -	AC 70...230 V
Tolerance of U_n		+ 15 %	+ 15 %	+ 15 %	+ 15 %
System leakage capacitance C_e μ F		≤ 1000	≤ 500 (150)	≤ 500 (150)	≤ 5
Response value R_{an} k Ω		1...10000 k Ω	1...10000 k Ω	1...10000 k Ω	50...500 k Ω
Coupled systems		■	■	■	
Locating current injector for insulation fault location		■	■	■	■
Installation	DIN rail	■			■
	Screw mounting	■			■
	Panel mounting/ wall fastening	■	■	■	
Interfaces	Web server	■			
	Modbus	TCP			
	BCOM	■			
	BS	■			
	BMS		■	■	■

Ordering information

Nominal system voltage U_n	Supply voltage U_s	Type ²⁾	Art. No.
AC, 3(N)AC 0...690 V, DC 0...1000 V	AC 100...240 V; 47...460 Hz / DC 24 V, 100...240 V	iso685-D-P	B91067030
		iso685-S-P + FP200	B91067230
AC 20...575 V, DC 20...575 V	DC 19.2...72 V AC 88...264 V/DC 77...286 V	IRDH575B1-427	B91065502
		IRDH575B1-435	B91065500
AC 20...150 V, DC 20...150 V	DC 19.2...72 V AC 88...264 V/DC 77...286 V	IRDH575B1-4227 ¹⁾	B91065505
		IRDH575B1-4235	B91065504
AC 340...760 V, DC 340...575 V	DC 19.2...72 V AC 88...264 V/DC 77...286 V	IRDH575B2-427	B91065506
		IRDH575B2-435	B91065503
AC 70...264 V, 42...460 Hz	$U_s = U_n$	isoMED427P-2	B72075301

¹⁾ Measuring voltage U_m 10 V for version -4227 for use in control circuits.

²⁾ Device „Option-W“ with increased shock and vibration resistance : Indicated by the letter „W“ at the end of the order number.

Insulation fault location system EDS

Fast localisation of insulation faults

Fast localisation and elimination of insulation faults is required by DIN VDE 0100-410 (VDE 0100-410). The IRDH575 in combination with the EDS system is a modular system to solve this problem. The application areas for EDS systems are highly diverse.

They are operated/used for **main and control circuits** in, for example:

- Power stations
- Hospitals
- Shipbuilding
- Traffic engineering
- Industrial plants
- Paper industry
- Oil and natural gas industry
- Mining, open-cast mining
- Rolling mills
- Mechanical engineering

Advantages of an insulation fault location system EDS

- Disconnection of the electrical installation is not required, insulation fault location takes place during operation
- Fast localisation of faulty circuits
- Information about the location of the fault is centrally displayed
- Combination with portable insulation fault location systems EDS3090/3090PG and EDS3091/3091PG
- Reduced maintenance and repair costs

Application example

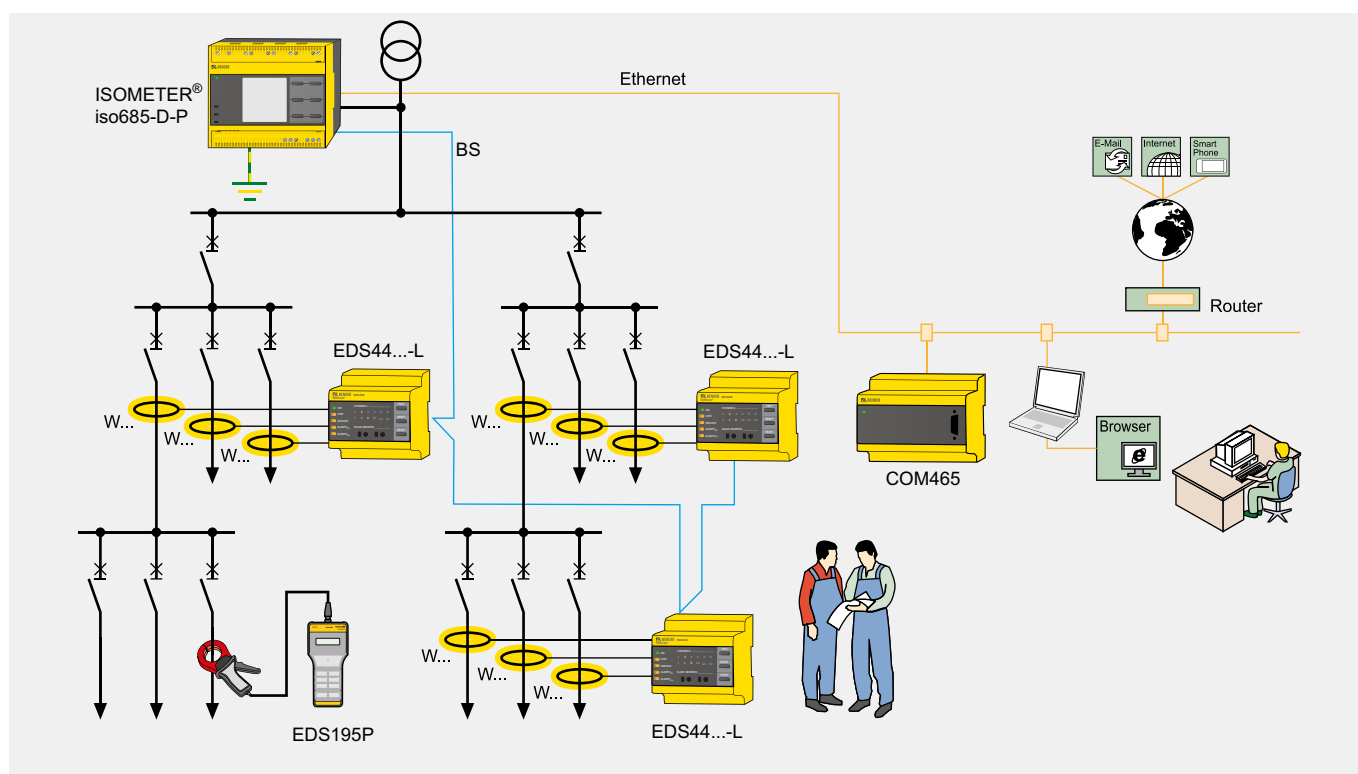

Insulation fault locators ISOSCAN®



Special applications		–	–	–	–	High-resistance insulation faults in case of high system leakage capacitances and low test current value
Circuits	Control circuits	–	–	■	■	■
	Main circuits	■	■	–	–	–
Voltage system	3(N)AC	■	■	–	–	–
	AC	■	■	■	■	■
	AC/DC	■	■	■	■	■
	DC	■	■	■	■	■
Nominal voltage U_n max		see Locating current injector (e. g. ISOMETER® iso685-D-P)	see Locating current injector (e. g. ISOMETER® iso685-D-P)	AC 20...276 V, DC 20...308 V	AC 20...276 V, DC 20...308 V	AC 20...276 V, DC 20...308 V
System leakage capacitance C_e μ F		acc. to characteristic curve	acc. to characteristic curve	acc. to characteristic curve	acc. to characteristic curve	acc. to characteristic curve
Response value R_{an} k Ω		acc. to characteristic curve	acc. to characteristic curve	acc. to characteristic curve	acc. to characteristic curve	acc. to characteristic curve
LED display		–	■	–	■	■
Installation	DIN rail	■	■	■	■	■
	Screw mounting	■	■	■	■	■
Interfaces		BB	BS	BB	BS	BS

Bestellangaben

Supply voltage U_s	Measuring range	LED display	Type	Art. No.
AC/DC 24...240 V	2...10 mA	–	EDS440-S-1	B91080201
		■	EDS440-L-4	B91080202
	0,2...1 mA	–	EDS441-S	B91080204
		■	EDS441-L-4	B91080205
		■	EDS441-LAB-4	B91080207

Application example

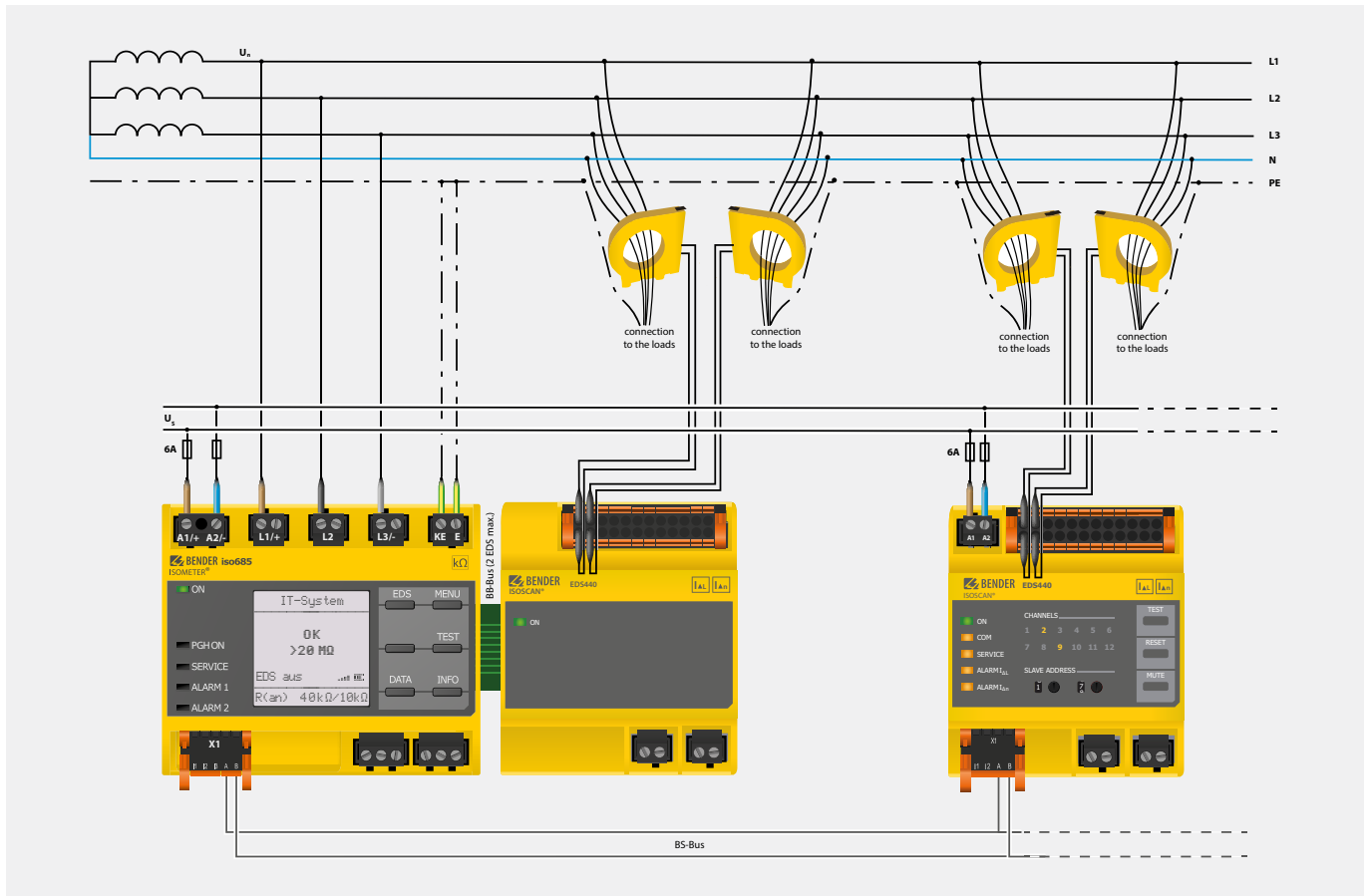

iso685, EDS440-S and EDS440-L

Insulation fault locators ISOSCAN®



Main circuit	■	–	■	–	■	–	■	–
Control circuit	–	■	–	■	–	■	–	■
U_s : DC 16...94 V, AC 16...72 V, 42...460 Hz	EDS460-D-1	EDS461-L-1	EDS490-D-1	EDS490-L-1	EDS460-L-1	EDS461-L-1	EDS490-L-1	EDS491-L-1
U_s : AC/DC 70...276 V AC 42...460 Hz	EDS460-D-2	EDS461-L-2	EDS490-D-2	EDS490-L-2	EDS460-L-2	EDS461-L-2	EDS490-L-2	EDS491-L-2
Scanning time	< 10 s for up to 1080 measuring channels							
Response value	2...10 mA	0.2...1 mA	2...10 mA	0.2...1 mA	2...10 mA	0...1 mA	2...10 mA	0.2...1 mA
Residual current indication	100 mA...10 A ¹⁾	10 mA...1 A	100 mA...10 A	10 mA...1 A	100 mA...10 A	10 mA...1 A	100 mA...10 A	10 mA...1 A
Parameter setting function	■				–			
Indication	LC graphical display				7-segment display/LED indication			
Error code indication	■							
Number of measuring channels	12							
Address range	1...90							
Internal clock (RTC)	■				–			
History memory	■				–			
Alarm relay "Common alarm"	2 x 1 changeover contact							
Alarm relay per channel	–		12 x 1 N/O contact		–		12 x 1 N/O contact	

Ordering information

Circuits	Measuring range		Alarm relay per channel	Supply voltage ¹⁾ U_s	Indication	Type	Art. No.		
	EDS function	RCM function							
Control circuit	0.2...5 mA	10 mA...1 A	–	AC 16...72 V, 42...460 Hz/ DC 16...94 V	LC graphical display	EDS461-D-1	B 9108 0005		
					7-segment display/LED indication	EDS461-L-1	B 9108 0007		
					AC/DC 70...276 V, AC 42...460 Hz	LC graphical display	EDS461-D-2	B 9108 0006	
						7-segment display/LED indication	EDS461-L-2	B 9108 0008	
					12 x 1 N/O contact	AC 16...72 V, 42...460 Hz/DC 16...94 V	LC graphical display	EDS491-D-1	B 9108 0013
							7-segment display/LED indication	EDS491-L-1	B 9108 0015
AC/DC 70...276 V, AC 42...460 Hz	LC graphical display	EDS491-D-2	B 9108 0014						
	7-segment display/LED indication	EDS491-L-2	B 9108 0016						
Main circuit	2...50 mA	100 mA...10 A	–	AC 16...72 V, 42...460 Hz/DC 16...94 V	LC graphical display	EDS460-D-1	B 9108 0001		
					7-segment display/LED indication	EDS460-L-1	B 9108 0003		
					AC/DC 70...276 V, AC 42...460 Hz	LC graphical display	EDS460-D-2	B 9108 0002	
						7-segment display/LED indication	EDS460-L-2	B 9108 0004	
					12 x 1 N/O contact	AC 16...72 V, 42...460 Hz/DC 16...94 V	LC graphical display	EDS490-D-1	B 9108 0009
							7-segment display/LED indication	EDS490-L-1	B 9108 0011
AC/DC 70...276 V, AC 42...460 Hz	LC graphical display	EDS490-D-2	B 9108 0010						
	7-segment display/LED indication	EDS490-L-2	B 9108 0012						

¹⁾ Absolute values

Measuring current transformers on request

Insulation fault locators ISOSCAN® with integrated measuring current transformers



Type		ISOSCAN® EDS150	ISOSCAN® EDS151
Application		Stationary	Stationary, Medical locations
Main circuit		■	–
Control circuit		–	■
Voltage system	3(N)AC	–	–
	AC	■	■
	AC/DC	■	■
	DC	■	■
Nominal voltage U_n max		–	–
System leakage capacitance C_e μ F		acc. to characteristic curve	acc. to characteristic curve
Response value R_{an} k Ω		acc. to characteristic curve	acc. to characteristic curve
Installation	DIN rail	–	–
	Screw mounting	■	■
	Panel mounting/wall fastening	–	–

Ordering information

Circuits	Measuring range	Response value		Supply voltage ¹⁾ U_s	Type	Art. No.
		EDS function	RCM function			
Control circuit	0.5...2.5 mA	0.5 mA	1 A	AC 17...24V, 50...60 Hz/ DC 14...28 V	EDS151	B 9108 0101
Main circuit	5...25 mA	5 mA	10 A		EDS150	B 9108 0103

¹⁾ Absolute values

Portable equipment for insulation fault location

Locating current injector PGH



Application	Main circuit		Control circuit
	energised	offline	energised
Nominal system voltage U_n	3AC, AC 20...575 V DC 20...504 V	3AC, AC 0...575 V DC 0...504 V	AC 20...265 V, DC 20...308 V
U_s AC 230 V	PGH185	PGH186	PGH183
U_s AC 90...132 V	PGH185-13	PGH186-13	PGH183-13
Locating current I_l max.	10/25 mA	10/25 mA	1/2.5 mA

Insulation fault locator



Type	EDS195PM
LC display	3 x 16 characters
Evaluating current $I_{\Delta L}$	0.2...50 mA
Response value	0.2 ... 1/2 ... 10 mA selectable

Measuring clamps



Type	PSA3020	PSA3052	PSA3165 (optional)	PSA3320	PSA3352
20 mm	■	–	–	■	–
52 mm	–	■	–	–	■
115 mm	–	–	■	–	–

Complete systems



Type	EDS3090	EDS3091
Application range	Main circuits	Control circuits

EDS309... components

Device type	Aluminium case with carrying strap	Operating manual	EDS195PM with accessories					PGH18... with accessories for							Measuring clamps			
			Insulation fault locator	Terminal connector 4 mm	Adapter BNC/4 mm plug for transformers	Adapter BNC-PS2 for WF transformers, optional	Plug-in power supply unit for EDS195P	Locating current injector	Power supply cable for PGH18...	Safety measuring lead, black	Safety measuring lead, green/yellow	Safety claw grip, black	Safety claw grip, green/yellow	Coupling device, optional (EDS3096PV only: included with delivery)	Measuring clamps 20 mm	Measuring clamps 52 mm	Measuring clamps 115 mm, optional	EDS set, optional
EDS3090	1	1	EDS195PM	1	1	1	1	–	–	–	–	–	–	–	PSA3020	PSA3052	PSA3165	1
EDS3090PG	1	1	EDS195PM	1	1	1	1	PGH185	1	3	1	3	1	AGE185	PSA3020	PSA3052	PSA3165	1
EDS3090PG-13	1	1	EDS195PM	1	1	1	1	PGH185-13	1	3	1	3	1	AGE185	PSA3020	PSA3052	PSA3165	1
EDS3091	1	1	EDS195PM	1	1	1	1	–	–	–	–	–	–	–	PSA3320	PSA3352	–	1
EDS3091PG	1	1	EDS195PM	1	1	1	1	PGH183	1	3	1	3	1	–	PSA3320	PSA3352	–	1
EDS3091PG-13	1	1	EDS195PM	1	1	1	1	PGH183-13	1	3	1	3	1	–	PSA3320	PSA3352	–	1
EDS3092PG	1	1	EDS195PM	1	1	1	1	PGH183 PGH185	2	6	2	6	2	–	PSA3320 PSA3020	PSA3352 PSA3052	–	1
EDS3096PG	1	1	EDS195PM	1	1	1	1	PGH186	1	3	1	3	1	AGE185	PSA3020	PSA3052	PSA3165	1
EDS3096PG-13	1	1	EDS195PM	1	1	1	1	PGH186-13	1	3	1	3	1	AGE185	PSA3020	PSA3052	PSA3165	1
EDS3096PV	1	1	EDS195PM	–	–	–	1	PGH186	1	3	1	3	1	AGE185	–	2 x PSA3052	–	–

Ordering information

Main circuits		Control circuits		Nominal voltage U_n	Supply voltage U_s	Type	Art. No.
with EDS	without EDS	with EDS	without EDS				
EDS460/490	–	–	–	AC 20...575 V, 42...460 Hz/DC 20...504 V	–	EDS3090	B 9108 2026
–	■	–	–	AC 20...575 V, 42...460 Hz/DC 20...504 V	AC 230 V, 50...60 Hz	EDS3090PG	B 9108 2021
–	■	–	–	AC 20...575 V, 42...460 Hz/DC 20...504 V	AC 90...132 V, 50...60 Hz	EDS3090PG-13	B 9108 2022
–	■	–	■	AC 0...575 V, 42...460 Hz/DC 0...504 V	AC 230 V, 50...60 Hz	EDS3096PG	B 9108 2025
–	■	–	■	AC 0...575 V, 42...460 Hz/DC 0...504 V	AC 90...132 V, 50...60 Hz	EDS3096PG-13	B 9108 2029
–	–	EDS461/491	–	AC 20...265 V, 42...460 Hz/DC 20...308 V	–	EDS3091	B 9108 2027
–	–	–	■	AC 20...265 V, 42...460 Hz/DC 20...308 V	AC 230 V, 50...60 Hz	EDS3091PG	B 9108 2023
–	–	–	■	AC 20...265 V, 42...460 Hz/DC 20...308 V	AC 90...132 V, 50...60 Hz	EDS3091PG-13	B 9108 2024
–	■	–	■	AC 20...265 V, 42...460 Hz/DC 20...308 V	AC 230 V, 50...60 Hz	EDS3092PG	B 9108 2030
–	■	–	■	AC 20...575 V, 42...460 Hz/DC 20...504 V	AC 230 V, 50...60 Hz		
–	■	–	–	AC 20...575 V, 42...460 Hz/DC 20...504 V	–	EDS3096PV	B 9108 2031

Bender monitoring systems seamless communication

Modern communication

Due to the fact that increasing demands are placed on communication capability, data transparency and flexibility, the use of modern fieldbus and network technologies has become a must. Hence, operating, warning and fault messages via the Web or the network, for example, substantially contribute to increasing the transparency of power supply systems, and also allow a fast reaction to critical operating states. In addition, important messages can be transferred via SMS or e-mails to the mobile phones or laptops of service personnel. Early information about the location and cause of a fault allow time and cost-efficient deployment of service personnel and can avoid equipment failure or damage to expensive devices.

Electrical Safety Management

The term "Electrical Safety management" means that Bender provides coherent solutions for the electrical safety of power supplies in all areas. Carefully matched products and systems with innovative measuring techniques, communication solutions for the visualisation of data from Bender monitoring systems as well as easy connection to fieldbus systems and to SCADA systems (Supervisory Control and Data Acquisition) provide the maximum possible safety, economic efficiency and transparency. The range of products is completed by comprehensive services, which extend right through the whole service life of the products.

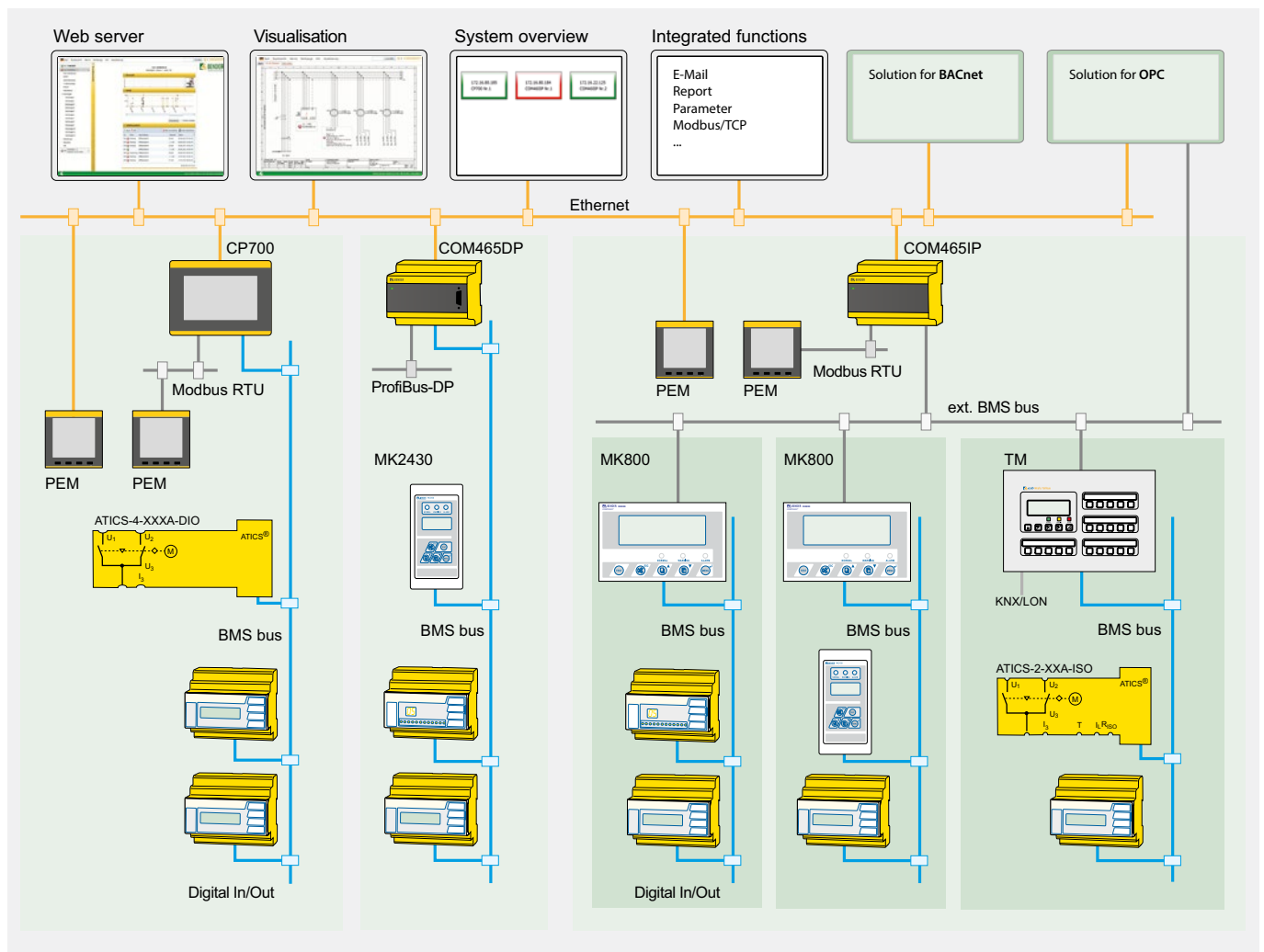



COM460IP

Condition Monitor with integrated gateway for the connection of Bender devices to Ethernet TCP/IP networks



COM462RTU

BMS-Modbus RTU gateway for the connection of Bender devices with BMS support using Modbus RTU



CP700

Condition Monitor with integrated gateway and touch screen for the connection of Bender devices to Ethernet TCP/IP networks



MK800

Universal alarm indicator and test combination for optical and acoustic signalling of alarm messages from BMS capable Bender monitoring systems.



MK2430

Universal alarm indicator and test combination for optical and acoustic signalling of alarm messages from BMS capable Bender monitoring systems.

Retrofit

Is your system still state of the art?

Even the most modern electrical systems cannot escape the marks of time. Whether diminishing operational reliability, changed legal stipulations or increasing energy costs: Upgrading to the respective current state of the art is indispensable. Products for monitoring energy quality and fault search are typically retrofitted.

Risk assessment according to operating safety regulations: Does your presently installed monitoring equipment recognise symmetrical and asymmetrical insulation faults?

Symmetrical and asymmetrical insulation faults present a high risk potential. Bender insulation monitoring devices continuously monitor your systems, insulation faults are captured and reported. Bender insulation monitoring devices comply with IEC 61557-8.

- We will check your electrical installations and provide you with recommendations on how to proceed further.

Bender delivers flexible solutions for retrofit projects

Modern monitoring methods can be integrated in older installations as well – also during ongoing operations. Retrofitting is possible via devices such as divisible transformers, whereby the transformers are not even required to be shut down nor must cable installations be disconnected.

Successor devices from Bender can conveniently replace older installations. Long-term availability is thus guaranteed.



POWERSCOUT®

Find out today what won't happen tomorrow

Moisture, deterioration, dirt, mechanical damage or faults due to the impact of current, voltage and temperature cause malfunctions in every electrical installation. The web-based software solution POWERSCOUT® helps you detect malfunctions at an early stage and eliminate the causes in an economically reasonable way. This guarantees high installation and operational safety and reduces costs.

Analysis – as individual as your system– as simple as possible

Predictive maintenance prevents downtimes, reduces costs and staff deployment. POWERSCOUT® informs you about the condition of your electrical installation at all times, since the meaningful visualisations with flexible dashboards can be retrieved via any display device: smartphone, laptop, computer. On request, POWERSCOUT® sends you graphically processed reports at specified intervals.

Continuous monitoring instead of random tests

Manual data acquisition is time consuming, error prone and only provides random sampling results. POWERSCOUT® gives you an insight into the entire data of your installation at any time, since all measured values are automatically and continuously saved. Your data is stored reliably and remains available for years.

Basis for periodic verification

The automated POWERSCOUT® report on residual currents forms the basis for measuring without switch-off by means of periodic verification. In order to maintain the correct status for electrical installations and stationary electrical equipment, periodic verification must be carried out.

This can be ensured, for example, by means of continuous monitoring of the installation carried out by qualified personnel. In this case, it would be smart to rely on continuous monitoring with multi-channel residual current monitoring systems (RCMS) and an evaluation (CP700) adapted to the system. The automatic POWERSCOUT® reports based on this monitoring enable the qualified person in charge to adjust the time limits for the insulation test within the context of periodic verification.

Analysis

- Continuously recording insulation values
- Recognising connections and optimising maintenance
- Cross-system evaluation possibilities
- Access from any place
- Supporting investment decisions

Predictive maintenance

- Higher availability
- Continuous monitoring
- Early detection of gradually developing insulation faults
- Early detection and reporting of short-time insulation degradation
- Less costs incurred due to unexpected malfunctions and shut-downs

Reports

- Historical comparisons
- Safe storage of measured values
- Event and alarm statistics

Web-based software solution
POWERSCOUT®



Support during all stages

Comprehensive service for your installation: remote, by phone, on site

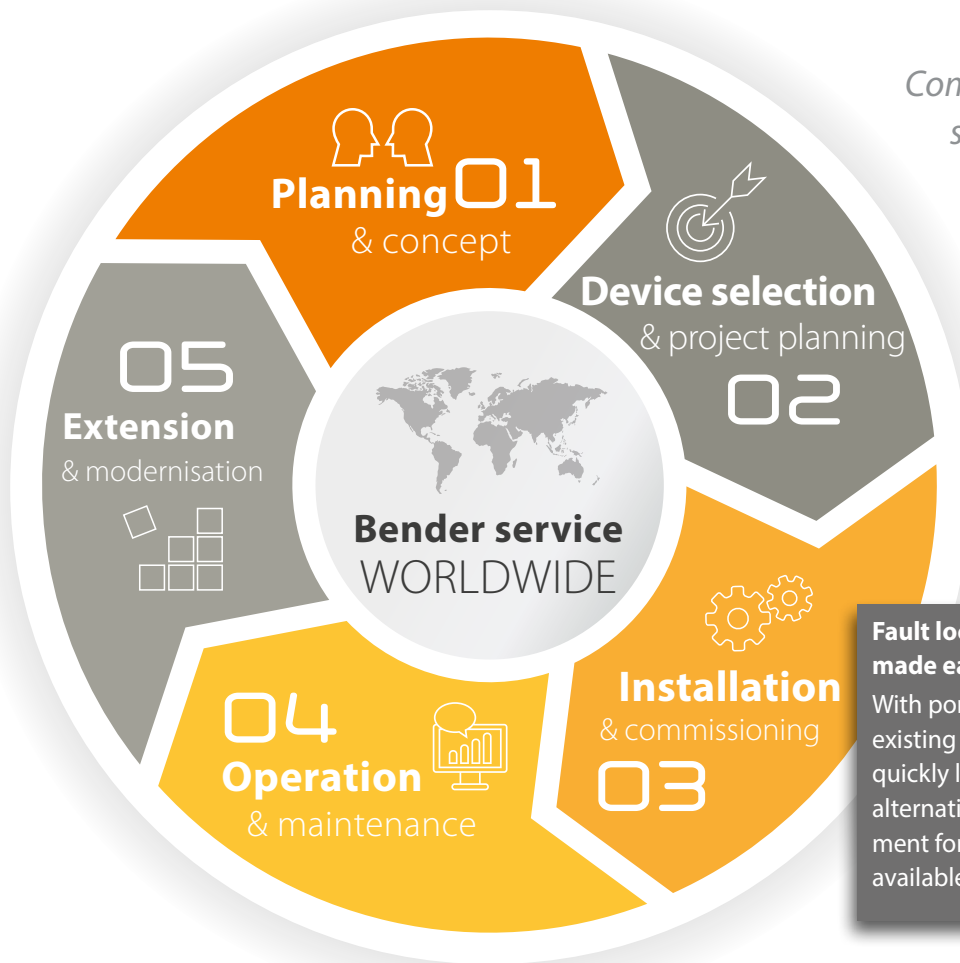

Competent service for maximum safety and high availability of your installation



Fault location – made easy

With portable fault location systems, existing insulation faults can be quickly located. They are the best alternative if no stationary equipment for insulation fault location is available.

From planning to modernisation – Our extensive know-how is at your disposal during all project phases.

Furthermore, with our first-class service we guarantee maximum safety for your electrical installations.

We offer services ranging from support over telephone to repairs and on-site service – with modern measuring devices and competent employees.

Secure yourself:

- High availability of your installation thanks to fast reaction to fault messages
- Increased profitability of your capital expenditure (CapEx) via optimised maintenance processes
- Targeted operating expenditure (OpEx) due to less downtimes and shorter service visits
- Support for your prospective system monitoring and regular tests of your system/power quality/monitoring devices
- Automatic control, analysis, correction, new settings/updates
- Competent assistance with setting changes and updates

Bender Remote Assist

Bender Remote Assist offers you support via remote access, high-quality service and advice for your challenging task consisting in ensuring consistent high safety in your systems.

Many service visits, fault clearance but also analyses and controls can be carried out remotely – without the expenses of time and money that an on-site visit of a technician implies.

This fast, efficient help and advice by our expert network allows the highest possible availability of your system.

Bender. So that your world is safer.

Our world is networked on a global scale; it is digital, mobile and highly automated – whether in manufacturing industry, inside or outside buildings, in operating theatres and power stations, in trains, underwater or underground: it never stands still and it is more dependent than ever on a reliable and, above all, safe electrical power supply.

And exactly that is our mission: we make electricity safe. Using our technologies we ensure that electricity is permanently available and guarantee faultless protection against the hazards of electric shock. We protect buildings, plants and machinery and therefore your investments and plans. But what we primarily protect are the lives of the people who are involved with electricity.

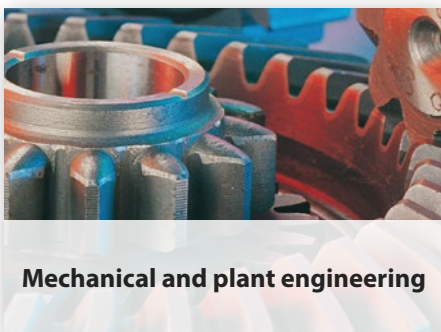

Mechanical and plant engineering



Oil, gas

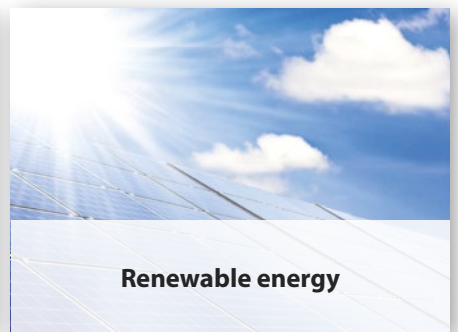

Renewable energy

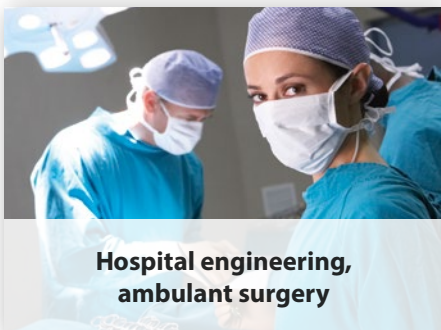

**Hospital engineering,
ambulant surgery**



Public power supply network

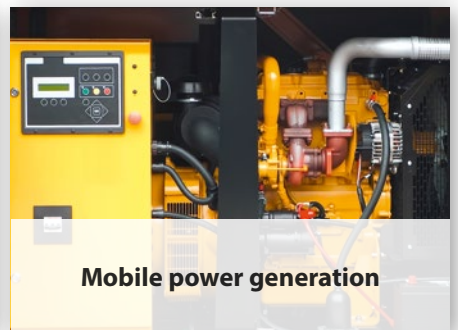

Mobile power generation



Ships and ports



Railway



eMobility

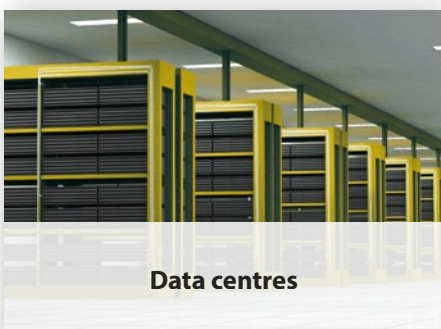

Data centres



Mining

www.bender.de



Bender GmbH & Co. KG

P.O.Box 1161 • 35301 Gruenberg • Germany
Londorfer Straße 65 • 35305 Gruenberg • Germany
Tel.: +49 6401 807-0 • Fax: +49 6401 807-259
E-mail: info@bender.de • www.bender.de

Photos: iStock (© Petair), Adobe Stock (© Rainer Fuhrmann), Fotolia (© Ostseefoto, © josemoraes, © Oleg-F, © Ramona Heim, © elgris, © tomas), 123RF (© Gerard Koudenburg, © Volker Rauch, © stefan 77), Thinkstock (© monkeybusinessimages), Bender archives.



BENDER Group